



MATFER BOURGEAT

USA

A PASSION FOR TASTE



COLLECTION 2019-2020



A PASSION
FOR TASTE



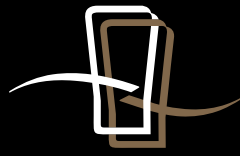

MATFER BOURGEAT USA

A PASSION FOR TASTE

QUALITY FRENCH MANUFACTURER SINCE 1814



CREATING PROFESSIONAL CHEF TOOLS SINCE 1814

Matfer Bourgeat is a French Industrial Group which is fully family owned. Over the past two centuries, the Group has become the industry leader in professional kitchens and laboratories around the world. Matfer Bourgeat USA., the American subsidiary for the Group, has been serving America's foodservice industry for 25 years.

A PASSION FOR TASTE

The Group sets the international standard in the pastry, bakery and restaurant industries. It is among a handful of suppliers worldwide that are able to provide a complete range of kitchen utensils and equipment for any foodservice establishment. Matfer Bourgeat is customer-focused, meeting the needs of food trade, conventional and luxury hotels, expert kitchens, fine dining and catering services.

COMMITMENT TO QUALITY & SERVICE

Superior Customer Service is the Group's number one goal. Quality and service are commitments through all processes of design, manufacturing, logistics, marketing and maximum safety requirements. We are dedicated to creating the most durable and hygienic products, like our famous EXOGLASS® composite material.

OUR INNOVATION COMES FROM YOU

Matfer Bourgeat launches 1,000 new products each year focusing on ergonomics, functionality and design to comply with customer and market needs. Manufacturing processes meet unique projects for every customer through consulting, product supply, demand matching, project management, supply chain and delivery anywhere in the world. Each year 100% of Matfer Bourgeat's profits are reinvested into product innovation.



A FOCUS ON SUSTAINABILITY

An ongoing objective is sustainable growth, which means maintaining quality while continuing to protect health and the environment. All of Matfer Bourgeat's industrial sites are either ISO 14001 certified (permanent reduction of environmental impacts) or in the process of certification. Responsible programs have been developed to reduce sound pollution, greenhouse gases and water waste. The Group's carbon footprint is considered during all decision making.



RESTAURANT, HOTEL, CRUISELINE OPENING SPECIALISTS

The Group's Eurochef network specializes in supplying kitchen equipment for up-scale hotels, exporting French quality into more than 80 countries. As a hotel opening specialist, we can help you define what products you will need based on your facility. We remain involved from start to finish at each opening and will go as far as providing a professional from our staff to receive and check merchandise upon delivery.



A MISSION TO GIVE BACK

Matfer, believes in giving back to make a difference. We are proud to participate in national, international and community outreach programs with a focus on charitable causes.



PREPARING FOR THE FUTURE

After a successful 200 years, the Matfer Bourgeat Group and America's Matfer Bourgeat Inc. have their sights clearly set on the future. In a changing fast-paced market, customers can always anticipate high quality and product innovations from Matfer Bourgeat.





MATFER BOURGEAT

USA

A PASSION FOR TASTE



CHEF DOMINIQUE TOUGNE
CHICAGO - USA

TABLE OF CONTENTS

- 6-8 NEW PRODUCTS
- 9 MAINTENANCE & WARRANTY
- 12-226 2019-2020 COLLECTION

BAKERY & PASTRY

- 12 MOLDS
- 14 BREAD PANS
- 17 CLOTHS & RACKS
- 18 BAKER'S BLADES
- 19 BREAD BASKETS
- 20 MOZAIK CONCEPT
- 22 WEDDING CAKE
- 24 MOLDS
- 31 FLEXIPAN INSPIRATION
- 32 MOLDS
- 43 FRAMES AND RINGS
- 51 MADELEINE SHEETS
- 52 FLEXIBLE MOLDS
- 59 FLEXIPAN®
- 66 SILFORM®
- 69 BAKING SHEETS & MATS
- 76 CUTTERS
- 79 COOLING RACKS
- 80 ROLING PINS
- 81 PASTRY BAGS & TIPS
- 89 THERMOMETERS
- 92 TOOLS

CHOCOLATE

- 104 MOLDS
- 113 GUITARS
- 115 FORKS
- 116 CONFECTIONERY

KITCHEN TOOLS

- 122 EXOGLASS UTENSILS
- 126 UTENSILS
- 138 WHISKS
- 140 STRAINERS, COLANDERS & FUNNELS
- 142 SALAD SPINNERS
- 143 SPATULAS & TURNERS
- 144 MIXING BOWLS
- 145 MEASURING TOOLS
- 147 GRATERS

SLICING

- 152 MANDOLINES
- 155 APPLE SLICERS
- 156 MATFER PREP CHEF
- 161 POTATO MASHER PREP CHEF
- 162 VEGETABLE / FRUIT SLICER
- 163 FOOD MILLS
- 165 PASTA
- 168 PASTA & PIZZA
- 169 CHEESE & TRUFFLE
- 170 CHOPPING
- 171 KNIVES

COOKWARE

- 181 CERAMIC
- 182 COPPER
- 186 STAINLESS STEEL
- 189 TRADITION
- 190 NON-STICK
- 192 BLACK STEEL
- 194 CAST IRON
- 196 SPECIALTY

TABLE TOP

- 202 BURGER CHIC
- 203 UTENSILS
- 204 PORCELAIN
- 206 SPECIALITY
- 209 MACARON DISPLAYS
- 210 SEAFOOD
- 212 MEASURING TOOLS
- 213 BREAD BASKETS

SMALL APPLIANCES

- 216 SOUS-VIDE
- 218 INDUCTION STOVES
- 219 FREEZING
- 220 PASTA, PASTRY & SUGAR WORK
- 221 JUICERS
- 222 SLICERS, STUFFERS
- 223 MEAT GRINDERS

PROTECTIVE APPAREL

- 226 PROTECTIVE APPAREL

- 228 ALPHABETICAL INDEX
- 234 NUMERICAL INDEX
- 241 TERMS & CONDITIONS OF SALE
- 241 CONVERSION CHARTS

NEW PRODUCTS 2019-2020

BAKERY AND PASTRY

17

TROLLEY FOR DOUGH CONTAINERS

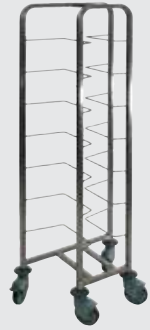

43

STAINLESS STEEL
EXTENDABLE FRAME



71

BACKING PAPERS EXOPAP



31

BUCHE CAKE DECORATION KITS

65

FLEXIPAN MOLDS



74

ALUMINIUM SHEET



EXOGLASS®

38

EXOGLASS® MOLDS



75

PERFORATED OVEN SHEETS



82

DISPOSABLE PASTRY
BAG DISPENSER



99

FOOD SPRAYER



NEW PRODUCTS 2019-2020

CHOCOLATE

109-110

CHOCOLATE MOLDS



115

CHOCOLATE FORKS



116

CHOCOLATE TRANSFERT STAMP



KITCHEN TOOLS

126

GARLIC PRESS/CUTTER



133

SAUCE SYRINGE



135

STAINLESS STEEL CHEF TONGS



139

SPIRAL WHISK



146

OVAL ICE CREAM SCOOP

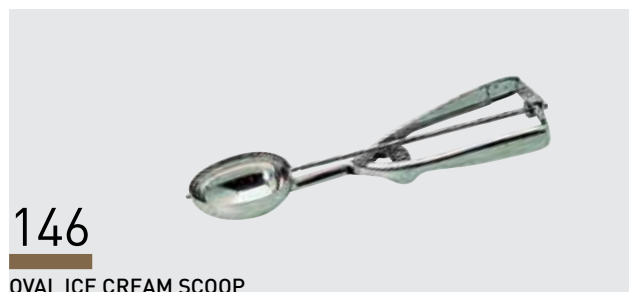

NEW PRODUCTS 2019-2020

SLICING



156

MASTER PREP CHEF MINI VERSION



158

ONIONS CUTTER PREP CHEF

COOKWARE



198

UTENSILS WALL RACKS

TABLE TOP



206

ESCARGOT PLATES



161

PREP CHEF BLADE BLOCK STORAGE SHELF



166

PASTA MACHINES

SMALL APPLIANCES



217

BEECHWOOD BAGS



167

PASTA DRYING RACK



168

PIZZA CUTTER



223

MEAT MINCER

MATFER PRODUCT WARRANTY AND COOKWARE MAINTENANCE

BOURGEAT COOKWARE WARRANTY

From the date of purchase, MATFER BOURGEAT guarantees to repair or replace any item found defective in material, workmanship or construction under normal use and following care instructions.

This excludes damage from misuse or abuse. As with any metal manufactured product, minor imperfections and slight color variations are normal. Completed Warranty Registration Form must be on file with MATFER BOURGEAT. MATFER BOURGEAT reserves the right to inspect any item claimed against warranty, user to pay freight to return product.

USE AND CARE INSTRUCTIONS FOR Non-stick AND STAINLESS COOKWARE
MATFER BOURGEAT non-stick cookware is manufactured with a state-of-the-art coating process. It is designed to last the lifetime of the pan under normal use.

- NEVER use metal utensils in the pan.
- Non-stick cookware is not meant to be cleaned in the dishwasher.
- Non-stick cookware should be hand washed in hot soapy water using a mild household detergent.
- NEVER use scouring pads, steel wool, bleach or any abrasive cleaner such as oven cleaners.
- Salt usage may cause pitting in the stainless cookware interior.
- To avoid salt damage, do not add salt to your food until the liquid begins to boil.
- Do not preheat an empty pan for more than one minute.
- Overheating can cause brown spots or blue stains.
- Food film left on the pan may cause discoloration and sticking.
- MATFER BOURGEAT stainless cookware is oven safe to 500°F; non-stick cookware is oven safe to 400 degrees Fahrenheit.
- Proper use of the cleaning product "Bar Keepers Friend" can be useful to remove stuck on food and discoloration.
- We highly recommend the use of Bourgeat Copper Cleaning Paste for all copper products.

INSTRUCTIONS FOR SEASONING YOUR MATFER BLACK STEEL FRY PAN :

1. Before use, wash pan under hot water in mild detergent, using a bristle brush, if necessary, to remove all protective coating. Thoroughly dry the pan.
 2. Sauté oil, salt and the skins of two potatoes on medium heat, continually swirling around entire pan. (The amount of these ingredients will vary depending the size of pan, i.e., for a medium pan, use 1/3 cup oil, 2/3 cup salt and the skins of two potatoes.)
Discard after sautéing for 15 minutes.
 3. Repeat Step 2 until pan is non-stick.
 4. After processing Steps 2 & 3, briefly reheat frying pan with a little oil, remove from heat and wipe with paper towel.
- AFTER USE:** Wipe with paper towel or rinse under hot water.
Do not use dish soap and do not allow pan to air dry.
Dry thoroughly by briefly placing on hot burner and re-grease lightly.
As you enjoy cooking with your Matfer Black Steel Pan, the color will naturally become darker until it is black.
Matfer Bourgeat's Black Steel Pans are designed for the foodservice industry and professional chefs.
As with any metal manufactured product, slight color variations, minor imperfections and irregularities, such as scratches, are normal and will in no way affect the performance of your pan.



CATALOG ICON DETAILS



DISHWASHER SAFE



NOT DISHWASHER SAFE



MICROWAVE SAFE



NOT MICROWAVE SAFE



OVEN SAFE



MADE OF EXOGLASS® INNOVATIVE COMPOSITE CREATED BY MATFER



ITEM FREE OF PERFLUOROCTANOIC ACID (PFOA) CHEMICAL



ITEM FREE OF POLYTETRAFLUOROETHYLENE (PTFE) CHEMICAL



NSF International is an accredited, third-party certification body that tests and certifies products to verify they meet these public health and safety standards. Products that meet these standards bear the NSF Mark, which is respected by consumers, manufacturers, retailers and regulatory agencies at the local, state, federal and international level.



This sign recognizes the quality allocated to the products by AFNOR in compliance with French and European technical standards and specifications. The NF marking guarantees that products purchased comply with regulatory requirements.



HEAT RESISTANCY UP FROM -40F TO +392°F



SEE MORE INFO ON ANOTHER CATALOG PAGE



HEAT RESISTANCY UP TO 500°F



COLD RESISTANCY UP TO -5°F



ALL HEAT SOURCES INCLUDING INDUCTION



BPA FREE



The Forest Stewardship Council (FSC), is a non-profit organization that sets certain high standards to make sure that forestry is practiced in an environmentally responsible and socially beneficial manner.



The UL Mark on Listed motors assures inspectors and authorities having jurisdiction (AHJ's) that the motor has been evaluated to globally recognized requirements for fire, electric shock and injury to persons. Manufacturers of end products know that UL Recognized component motors have been tested and evaluated to rigorous requirements for safety of rotating machinery designed to be factory installed.



CHEF JASON LICKER
SAN DIEGO - USA

BAKERY AND PASTRY





EXCLUSIVE TO MATFER : EXOGLASS® THE NEW GENERATION OF PASTRY MOLDS



TESTIMONIAL



"Matfer's Exoglass® molds make my everyday work easier. I really appreciate their utilization qualities. Raised dough does not oxidize the molds, making cleaning easy and fast by hand or in the dishwasher. This material means that I no longer need to grease except for really soft doughs such as fluted patterns and cakes. I can mold-release my tarts, cakes or loaves immediately after removing them from the oven, without any risk of burns. They have beautiful even deep browning, making you want to bite into the cake. I sell a great number of cakes and the individual cake molds by Exoglass® mounted on a plate, gain a lot of handling time. Buying these molds is a long-term investment guaranteeing the quality of work of my teams and regular quality of the products sold to my customers in the shop". M. CAPEZZONE - Baker Pastrymaker in Paris, FRANCE.

EXOGLASS® MOLDS

PERFECT COOKING AND COLORATION, EASY REMOVAL !

Made of an innovative composite material suitable for both savory and sweet creations.

This material gives regular coloring of preparations, and excellent heat diffusion for the most complex recipes.

Performance and output in terms of cooking make these EXOGLASS® molds the perfect general-purpose product.



- Extra heat resistancy: Usable from -4°F to 482°F.
- Non-deformable & long lasting.
- Natural non-stick surface for easy removal & in most cases : no greasing is necessary.
- Dishwasher safe.





EXAL MOLDS



ALUMINUM NON-STICK:
Thick aluminum with a multi-layer non-stick coating inside and enamelled outside. The perfect general purpose mold, the Exal provides excellent diffusion of heat for oven cooking. It is also recommended for savory preparations. Exal molds are dishwasher and freezer safe.



EXOPAN MOLDS



STEEL NON-STICK:
Fine steel with a non-stick coating inside and protective enamel outside. Ideal for cooking pastry, the EXOPAN combines the quality of cooking in tinplate with the benefits of a non-stick surface. The fineness of the steel contributes to the overall development of product color. Simply wipe clean inside and outside. This material should not be exposed to humidity (dish-washer, fridge...).

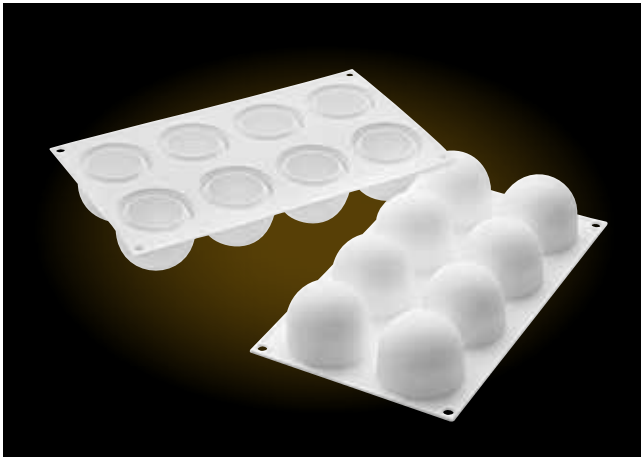

SILIKOMART® 3D MOLDS



Silicone. Wide range of stylised and innovative products. Functional, practical and aesthetically pleasing, these products are sure to satisfy the requirements of all those that love to cook.

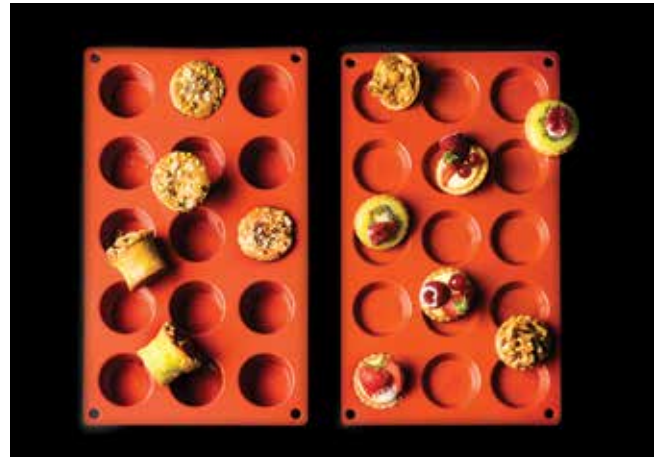

GASTROFLEX® MOLDS

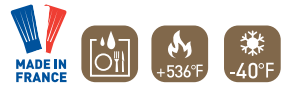

Made of extra strong pure food grade silicone. Provides even cooking results. Quick and easy to handle. No greasing, easy to clean. Dishwasher safe.



FLEXIPAN® MOLDS



Flexible structure in silicone coated glass fiber, designed for easy removal from the mold. For cooking and refrigerating savory or sweet products. Available in sheets, Flexipan® molds are very well-adapted to series production. Guaranteed for 2,000 to 3,000 uses. Easy clean-up in water.





PERFECT COOKING AND COLORING OF DOUGH!

EXOGLASS® BREAD MOLDS

Innovating composite material created by MATFER guarantees a very homogeneous dough-cooking and color. Very resistant, made for complying with the requirements of modern bread-making.

They can be used for sweet dough cooking (cakes, brioches) with prior greasing. Cooking on baking sheet recommended. Regular oiling facilitates turn out.

- Super heat resistant to 482° F.
- Freeze resistant from -4° F.
- Non-deformable & long lasting.
- Non-stick.
- Dishwasher safe.
- Unbreakable under normal conditions.



EXOGLASS® BREAD MOLD WITH LID
Stainless-steel sliding lid.

EXOGLASS® BREAD MOLD

Item #	L"	W"	H"	Bottom W"	Capacity
345933	7 1/4	3 1/3	3	3	300 g - 3/4 lb.
345934	9 3/4	3 1/2	3 1/4	3	500 g - 1 lb.
345935	10 1/2	4	3 1/2	3 1/2	800 g - 1 2/3 lb.
345936	11 1/3	4 1/3	4	4	1 Kg - 2 lbs

Item #	L"	W"	H"	Bottom W"	Capacity
345833	7 1/4	3	3 1/2	3	300 g - 3/4 lb.
345834	9 3/4	3	3 1/2	3 1/4	500 g - 1 lb.
345835	10 1/2	3 1/2	4	3 1/2	800 g - 1 2/3 lb.
345836	11 1/3	4	4 1/3	4	1 kg - 2 lbs.
345842	15 3/4	4 3/4	4 1/3	4 1/3	1.8 kg - 4 lb.s



EXOPAN STEEL NON-STICK FLARED BREAD MOLD

Edge rolled around a copper wire for ultimate heat distribution.

Item #	L"	W"	H"	Capacity
331094	6 1/3	2 1/2	2 1/3	17 oz.
331095	7 1/16	2 3/4	2 1/2	22 oz.
331096	7 7/8	3 1/6	2 3/4	30 oz.
331097	8 2/3	3 1/3	3	1 1/4 qt.
331098	9 1/2	3 1/2	3 1/6	1 5/8 qt.
331099	10 1/4	3 3/4	3 1/3	1 7/8 qt.
331101	11 7/8	4 1/6	3 3/4	2 5/8 qts.



EXOPAN STEEL NON-STICK BREAD MOLD

Edge rolled around a copper wire for ultimate heat distribution.

Item #	L"	W"	H"	Capacity oz.
331071	5 1/2	2 7/8	2 3/4	23 1/3
331072	6 1/3	3	3	30 1/2
331073	7 1/8	3 1/6	3 1/6	33 7/8
331074	8	3 1/6	3 1/6	38 7/8
331075	10	3 1/6	3 1/6	49
331076	12	3 1/6	3 1/6	59 1/6
331077	15 3/4	3 1/6	3 1/6	84 1/2
331078	19 2/3	3 1/6	3 1/6	108 1/6

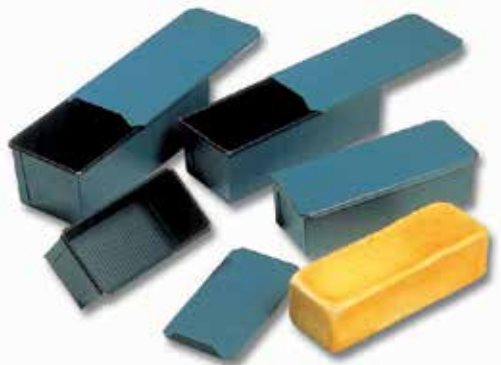

EXOPAN STEEL NON-STICK BREAD MOLD WITH LID

Edge rolled around a copper wire for ultimate heat distribution.

Item #	L"	W"	H"	Bottom W"	Capacity
340853	7 1/4	3 1/3	3	3	300 g - 3/4 lb.
340854	9 3/4	3 1/2	3 1/4	3	500 g - 1 lb.
340855	10 1/2	4	3 1/2	3 1/2	800 g 1 2/3 lb.
340856	11 1/3	4 1/3	4	4	1 Kg - 2 lbs.



EXOPAN STEEL NON-STICK MINI LOAF MOLD

A straight shape for baking sweet or savory mini loaves to take away or serve on a buffet. Baking mini loaves that are easy to handle and easy to eat becomes a real pleasure.

Item #	L"	W"	H"	Capacity oz.
331082	7 1/8	1 3/4	1 3/4	12 1/3



EXOPAN STEEL NON-STICK BREAD MOLD

Edge rolled around a copper wire for ultimate heat distribution.

Item #	L"	W"	H"	Item #	L"	W"	H"
341601	5 1/2	3	3	341604	8	3	3
341602	6	3	3	341606	7	3 1/3	3
341603	7	3	3	341607	10	3 1/2	3

EXOPAN STEEL NON-STICK LONG BREAD MOLD WITH LID

Edge rolled around a copper wire for ultimate heat distribution.

Item #	L"	W"	H"
341641	15 3/4	4	4
341642	15 3/4	4 3/4	4 3/4
341643	15 3/4	5 1/2	5 1/2



EXOPAN STEEL NON-STICK LARGE BREAD MOLD

Wide toast pan with edge rolled around a copper wire for ultimate heat distribution.

Item #	L"	W"	H"	Base"
340961	15 3/4	4	3 1/8	3 1/2

RECOMMENDED FOR BAGUETTES AND VIENNESE BREAD



CHANNEL FRENCH BREAD PAN

Special crimped aluminum alloy which prevents dough from sticking and improves the aspect of the crust.

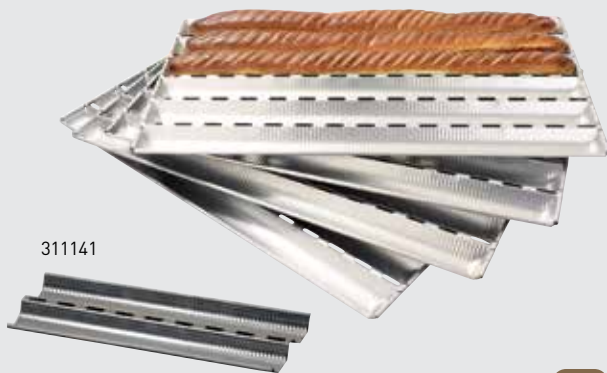

- Resists freezing, heating, high humidity, fermentation, yeast & salt.
- Excellent heat conductive material.
- Black anodised for better heat absorption.
- Use for controlled fermentation chamber and freezing chambers.
- Easy to store due to its stackability.
- No retreatment needed, only slight and regular greasing.

Item #	L"	W"	Wt	# of Ch.	Ch. Ø"
311121	25 1/2	17	2 lbs. - 13 oz.	6	2 3/8
311141	17 3/4	5 1/2	8 oz.	2	2 3/8



TRIPLE ROUND BREAD MOLD

Made of heavy duty stainless steel. 3 molds attached in 2 parts with two clamp closures.

Item #	L"	Ø"
341712	11 3/4	2 3/4
341713	11 3/4	1 3/4

STAINLESS STEEL SMALL ROUND BREAD PAN

Makes round breads for canapes or tea sandwiches. The advantage of using this piece of equipment is that it will produce even round bread.



Item #	L"	Ø"
341711	11 3/4	1 3/4
341716	11 3/4	2 3/4
341717	14 1/6	2 3/4



- Reusable between 2000 and 3000 times.
- Super heat resistant.
- Non-stick: No greasing is necessary.
- Clean with a sponge.
- Ideal to bake hoagies for sub sandwiches.

SILFORM SUB ROLLS

Made of woven glass fabric, impregnated and coated with food grade silicone. Pre-formed and gives total flexibility. Provides the best possible use of trays and racks in the bakery.

Item #	Ch. Name	Ch. #	Ch. Size"
60-02955	Sub Roll	5	11 7/8, 3
60-02954	Sub Roll	4	16, 2 5/8
60-04207	Sub Roll	7	16, 3
60-04206	Sub Roll	6	16, 3 5/8
60-06208	Baguette	8	24, 1 3/4
60-06204	Baguette	4	24, 3 5/8



- Allows thorough drying and brushing of cloths to extend the life duration.
- Folded when empty = gain in space.

DRYING RACK FOR LINEN LINERS

Stainless steel wall rack with 24 pivoting bars. Drying position with lockable spacing of 2" between bars. Bars can be folded separately from the rack to make space and facilitate the hanging of linens. 30 1/5" long bars. Recommended fixing height: 5 7/8" from the ground. 7 screws and 7 wall plugs supplied.

Item #	Wall rack W"	W of folded supports "	H "
845025	57 3/4	86 1/2	14



TROLLEY FOR DOUGH CONTAINERS

Stainless-steel pipe rack, stainless-steel wire Ø 8 mm (1/3"). Composite wheels of which 2 with brakes. Suitable for all models: round H190 mm (7 1/2") max and classical rectangular containers, 530 x 410 mm (20 7/8" x 16 1/6"). Distance between the 2 levels: 185mm (7 1/4"). Fits up to 8 containers (779108) or 16 containers (779110).

Item #	L "	W "	H "
779108	14 1/2	23 1/4	70 1/2
779110	31	23 1/4	70 1/2



HYGIENIC RANGE BRUSH

Polypropylene handle. Polyamide fibers. Sterilizable. Used to brush natural linen cloth.

Item #	L "	W "	H "
710083	8	2 1/2	2 1/2



ROUND DOUGH CONTAINER

Made of PEHD.

Item #	Ø "	H "	Capacity qts.
510531	18 7/8	4 3/4	14 3/4
510532	18 7/8	7	21 1/6



Item #	
510534	LID FOR ROUND DOUGH CONTAINER



RECTANGULAR DOUGH CONTAINER

White PEHD. Heavy duty.

Item #	L "	W "	H "	Capacity
510505	20 7/8	16 1/8	3 1/8	10 L / 10.5 qt.
510501	20 7/8	16 1/8	5 3/4	21 qt.
510508	LID FOR RECTANGULAR DOUGH CONTAINER			
510535	23 3/4	15 3/4	3 1/6	12 2/3
510536	23 3/4	15 3/4	4 1/3	21 1/6
510537	LID FOR RECTANGULAR DOUGH CONTAINER			

DOUGH FERMENTATION ANTI-MOULD CLOTH

20 metres roll. Anti-mould. 100% natural linen. Ideal for freezing.

Item #	W "	H "
118580	27	9/16



100% BIODEGRADABLE LINEN



DOUGH FERMENTATION CLOTH

100% NATURAL LINEN. 21 7/8 yard roll. Maintenance: washing not recommended. Regular brushing and drying.

Item #	W "	Density g/m ²
118560	23 5/8	380

PATENTED STAINLESS STEEL HOLDER FOR RAZOR BLADES OFFERING MANY ADVANTAGES



CAUTION : THE MATFER BLADES ARE SLICING TOOLS AND AS WITH ALL SLICING TOOLS THEY MUST BE HANDLED WITH CARE. THEY MUST NOT BE LEFT WITHIN REACH OF CHILDREN.

LAM'PLUS BAKER'S BLADE WITH REPLACEABLE BLADE

Product designed by the baker Jean-Christian Horel, and manufactured by Matfer.



- Special stainless steel holder can be turned in all directions to suit the hand and movement of each baker : the 4 corners of each blade can be used.
- Blade cover for safe usage, providing protection from the 2 rear corners of the blade. Blades are held firmly in place.
- Extra flat shape designed to avoid the dough sticking to it.
- Lightweight and easy to assemble.

Item #	L"	W"
120032	5	1
120034	Pack of 250	REPLACEABLE BLADES
120035	Pack of 40	REPLACEABLE BLADES



BAKER'S BLADE

Double edged stainless steel with plastic handle. Cuts ridges into baguette to facilitate rising of dough. Handle with care. Store in sleeve.

Item #	L"	Wt
120005	6	5 oz.
120006	6	1 lb. 8 oz. Pack of 12



- LIGHT AND EASY TO HANDLE.
- SPECIAL SHAPE: ERGONOMIC.
- MADE OF A SINGLE PIECE: HYGIENIC.
- SAFE TO USE: Blade is not dangerous to handle.
- 100% recyclable.
- High-quality cutting of moist dough, firm dough, dough with grains, crusty dough.
- Longevity: 5,000 to 10,000 baguettes depending on hydration.
- Prevents dough sticking to blade.
- Special shape: traditional cutting with a blade; "Polka" cutting with two opposing and overlapping blades; "Sword" cutting with two superimposed blades.

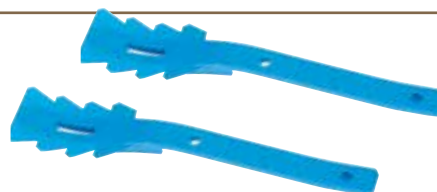

BAKER'S BLADE

Created by a baker. Delivered in a Blibox box with a magnetic hook and a 2-blade storage case.

Item #	L"	Wt g
120025	4 3/4	3 Pack of 12
120026	4 3/4	3 Pack of 50



STAINLESS STEEL DOUGH BLADE

Stainless steel dough blade right side.

Item #	L"	Wt oz.
120054	5 3/4	5 Blister of 2



CARBON STEEL BAKER'S BLADES

The real professional's baker blades. Dry thoroughly after usage. Store in sleeve. Pack of 12.

Item #	L"	Wt oz.
120023	4 3/4	15 Large round tip
120022	4 3/4	15 Medium round tip



Round

Crown

BANNETON LINEN LINED BASKET

Crafted of wicker and linen lined. This basket allows you to proof and imprint its shape into all your special and mixed dough. Great for country-style breads and can also be used for tabletop service.

Item #	Type	Ø "	H "	Capacity lbs.
118510	Round	8 1/4	4 3/4	1
118511	Round	9 1/2	4 3/4	2
118512	Round	10 5/8	4 3/4	3
118513	Round	11 1/2	4 3/4	4
118520	Crown	10 1/4	3 1/2	1
118521	Crown	11 3/4	3 1/2	1 1/2
118522	Crown	12 1/2	3 1/2	2 1/6
118523	Crown	13 3/8	3 1/2	3 1/3



WICKER BASKET ROUND LINEN LINED

Ideal for tabletop service.

Item #	Ø "	Wt oz.
573476	8 3/4	4



1- WICKER BASKET FOR BREAD

Format suitable for traditional baguettes.

Item #	Ø "	Wt lbs.
573421	11	3

2- BREAD BASKET

HDPE. Solid bottom. Stackable when empty. Format Suitable for Tradition Baguettes.

Item #	L"	W"	H"	Capacity qts.
511006	25 1/8	17 3/4	21 7/8	127

3- STACKABLE NESTABLE CONTAINER

Polyethylene. Base and side slits, for bakery goods. Stackable. Up to 75% nestable when empty.

Item #	L"	W"	H"	Capacity qts.
511005	23 3/4	15 3/4	4 3/4	21



POLYPROPYLENE AERATION BREAD BASKET

These bread baskets faithfully reproduce the traditional bread basket shapes and assure aeration of the dough during rising thanks to their special structure.

Dishwasher-safe. Very resistant, they improve the bread preparation hygiene.

Item #	Type	L-W/Ø "	H "	Cap lbs.
118541	Oval	8 1/4 - 5 7/8	3 1/3	1
118547	Round	Ø 7 7/8	3 1/3	1 - 1 1/2
118550	Round	Ø 10 2/3	3 1/3	3 1/3 - 4 3/8



BANNETON WILLOW BASKET

Crafted of Willow. This basket allows you to proof and imprint its shape into all your special and mixed dough. Great for country-style breads and can also be used for tabletop service.

Item #	L "	W "	Wt oz.	Shape	Capacity of dough
118501	7 7/8	4 3/4 "	6	Oval	
118502	9 1/2	6 "	6	Oval	
118505	7 1/2		6	Round	
118506	10 1/4		11	Round	



118515
118516

118125
118126

118128

Item #	L "	W "	H "	Shape	Capacity of dough
118515	16 1/4	3 3/4	2 1/4	Long	10 oz.
118516	18	4	2 1/4	Long	1 lb.
118525	7	7 1/4	3 1/4	Triangle	1 lb.
118526	9	9	3 1/4	Triangle	2 lbs.
118528	8 3/4	8 3/4	3 1/4	Square	2 lbs.

STAND OUT: COMBINE COLORS, DESIGNS AND FLAVORS!

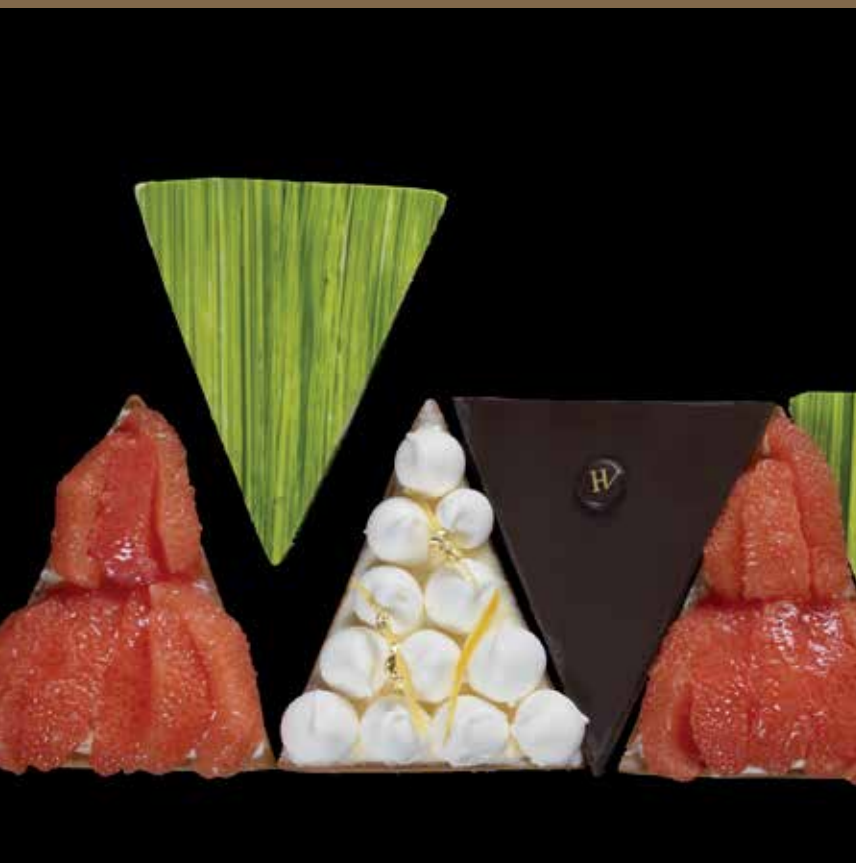

MOZAİK

Mozaik triangles, rectangles, squares and oblongs and their cutting tool transport us to the presentations of the great classical pastry cooks.

The combination of delicate tastes and greedy colors for the same tart will surprise your customers.

With the specially designed cutter, the pastry is cut with precision to make tart bases with clean outlines and regular edges.



- Presentation combinations: bands, stars, hexagons, triangles.
- The sections of the tart can be assembled into a round, square, etc.
- Shapes and cutters of stainless steel. Patented model.



MOZAİK TRIANGLES

Stainless steel. 8 pieces create a pie of \varnothing 9 1/2".

Item #	L"	W"	H"
371142	4 3/4	3 7/8	3/4
371242	Tart base cutter, stainless steel		

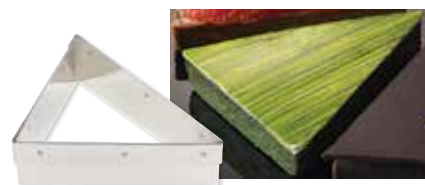

MOZAİK DECORATION TRIANGLE CUTTER

Cutter with reinforcing band for Mozaik triangular tarts. Can be used as a savory pastry cutter. Stainless steel.

Item #	L"	W"	H"
371243	4 5/8	3 1/2	1 1/2

SUPPLY INDIVIDUAL TARTLETS OR COMBINATIONS OF FORMS AND SWEET OR SAVORY FLAVORS



MOZAÏK FINGER TARTLET MOLD

Stainless steel. Pack of 4.

Item #	L"	W"	H"
371153	4 3/4	1 1/2	3/4



MOZAÏK RECTANGULAR TART CUTTER

Cutter with reinforcement for Mozaïk rectangular tart bases with clean outlines and no wasted dough in the corners. Stainless steel.

Item #	L"	W"	H"
371253	6 1/2	3	1 1/3

MOZAÏK FINGER TARTLET OVAL MOLD

Stainless steel. Pack of 4.

Item #	L"	W"	H"
371152	5 1/6	1 1/2	3/4



MOZAÏK TART SQUARE MOLD

Stainless steel. Pack of 4.

Item #	L"	H"
371121	3	3/4
371123	3 1/2	3 1/2

SQUARE CUTTER

Pack of 4.

Item #	L"	H"
371221	4 1/5	3
371223	3 1/2	3 1/2



LOG FRAME "LINGOT" STAINLESS STEEL

Frame for the making of lingot-style yule logs. Cut in two the yule-log serves 8, in thirds it serves 6 portions. Stainless steel. Designed by Hugues Pouget.



Item #	L"	W Bottom	W Top"	H"
371161	22 1/4	3 3/4	2 2/3	1 1/2



LOG FRAME "LETTER TO SANTA CLAUS" STAINLESS STEEL

Item #	L"	W"	H"	h"
371162	22 1/4	3 2/3	2 3/4	1 5/8



MOZAÏK TARTLET OVAL MOLD

Stainless steel.

Item #	L"	H"
371330	7 7/8	1
371334	9 1/2	1
371338	11	1
371324	9 1/2	1 3/4
371328	11	1 3/4

UNIQUE AND PATENTED SYSTEM OF STACKABLE INSERTS AND STAINLESS STEEL FRAMES



FRENCH STYLE WEDDING CAKE

This unrivaled and patented system consists of superimposed inserts and stainless steel frames allowing a spectacular architecture to be put up in record-breaking time. The assembly includes wedges to allow the assembled cake to be transported safely.

Tier height: 3 1/6"
Total height: 15 3/4"



- Facilitates cake assembly.
- Ensures safe transportation of the finished cake to its delivery location.
- Makes cake cutting easier.
- Allows infinite number of possible tastes and textures.

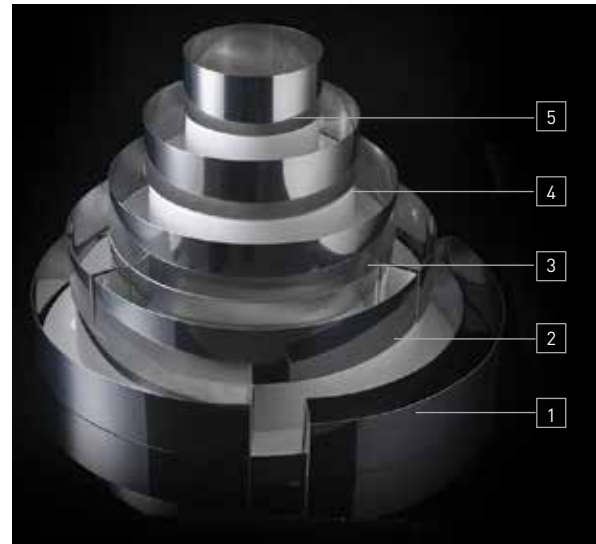

The full wedding cake structure consists of 5 layers.
Complete kit = 5 inserts + 5 stainless steel shapes

Tiers		ROUND	SQUARE/ DEC
5	Conventional stainless steel shapes assembly	Ø 6 1/3"	3 1/6" X 3 1/6"
4	Assembly of stainless steel shapes directly on insert	Ø 10 1/4"	7" X 7"
3	Assembly of stainless steel shapes directly on insert	Ø 10 1/4"	11" X 11"
2	3 shaped tiers or 4 rectangular, stainless steel	Ø 18 1/6"	15" X 15"
1	3 shaped tiers or 4 rectangular, stainless steel	Ø 22"	18 7/8" X 18 7/8"

THE SYSTEM CONSISTS OF:

- 5 ABS reusable and superimposed dessert supports.
 - 3 round, square or de-structured square frames of stainless steel.
 - 2 sets of 3 stainless steel circle tiers finally forming 2 crowns of desserts or 2 sets of 4 rectangles depending on shape.
- The sizes of these components will allow storage and refrigeration on pastry grilles measuring 600 x 400 mm. Thermoformed inserts with open handles for easy handling of the cake tiers for assembly and superposition.



STUNNING ARCHITECTURE MADE IN THE FRENCH CAKE MAKING TRADITION



© Studio Gala

PROCESS



1 | Cutting out the sponge



2 | Lining



3 | Filling



4 | Unmolding

5 | Assembly

The desserts are all 2" wide. This makes them easy to cut into portions.

POSSIBLE NUMBER OF PORTIONS (size : 2" X 2" X 3 1/6"):

5 tiers = 160 portions (±125 ml) or 200 portions (±100 ml)

4 tiers = 115 portions (±125 ml)

3 tiers = 70 portions (±125 ml)

FRENCH STYLE WEDDING CAKE COMPLETE KIT

Stainless Steel.

Item #
681901 ROUND
681902 SQUARE
681903 DECONSTRUCTED

SET OF 5 STAINLESS STEEL SHAPES

Stainless Steel.

Item #
681911 ROUND
681912 SQUARE
681913 DECONSTRUCTED

SET OF 5 ENTREMETS STANDS - ABS

Item #	
681921	ROUND
681922	SQUARE
681923	DECONSTRUCTED



ROUND PLEXIGLASS STAND FOR WEDDING CAKE

Item #	Ø"
681934	26 3/4



EXOGLASS® PASTRY MOLDS

Made of an innovative composite material suitable for both savory and sweet creations. Performance and output in terms of cooking make these EXOGLASS® molds the perfect general-purpose product.

- Extra heat resistancy: **USABLE FROM -4°F TO 482°F.**
- Non-deformable & long lasting.
- Natural non-stick surface for easy removal & in most cases: no greasing is necessary.
- Dishwasher safe.



EXOGLASS® CANNELE BAKING SET
Set - Tray & Molds.

Item #	Mold Ø"	
347415	1 1/3	30 molds
347416	1 3/4	25 molds
347417	2 1/6	16 molds



EXOGLASS® CAKE BAKING SET

Stainless steel tray holds 15 individual Exoglass® cake molds. Easy and fast handling for filling and baking. Molds are removable for cleaning and lock into place on the sheet with clips.

Item #	L"	W"	
347060	12	15 3/4	Set - Tray & 15 molds



EXOGLASS® REPLACEMENT CANNELE MOLDS
Pack of 6.

Item #	Ø"	H"
345415	1 1/3	1 1/3
345416	1 3/4	1 3/4
345417	2 1/6	2 1/6



EXOGLASS® REPLACEMENT MOLDS

Item #	L"	W"	H"	
345060	3 1/2	1 1/2	1 1/2	Pack of 6



EXOGLASS® RAMEKIN MOLD
Pack of 6.

Item #	Ø"	H"	Wt oz.
345604	3 1/8	1 1/2	4



EXOGLASS® KUGELHOPF MOLD
Pack of 6.

Item #	Ø"	H"
345638	3 3/4	2 1/2



EXOGLASS® OPEN SAVARIN MOLD
Pack of 12.

Item #	Ø"	H"	Capacity oz.
345621	2 3/4	5/8	1 1/2
345622	3 1/6	2/3	2 1/5



EXOGLASS® ROUND BABA MOLD
Pack of 6.

Item #	Ø"	H"	Capacity oz.
345591	1 1/4	1 1/4	2
345592	2	2	2 3/4
345593	2 1/3	2 1/3	3 1/3
345594	2 1/2	2 1/2	4 3/4
345595	2 3/4	2 3/4	7 1/2



EXOGLASS® PLAIN ROUND TARTLET MOLD

Item #	Ø"	H"	
345233	2 3/4	3/8	Pack of 24
345234	3 1/6	15/32	Pack of 24
345235	3 1/2	1/2	Pack of 12
345235	4	5/8	Pack of 12

EXOGLASS® BRIOCHE MOLD



MORE INFO P. 28



Item #	Ø"	H"	Flutes	
345233	2 3/4	1 1/10	12	Pack of 24
345234	3	1 1/10	10	Pack of 12
345235	3 1/6	1 1/6	10	Pack of 12



CANNELE COPPER TIN LINED MOLD

Originally a mold for a special cake from the Bordeaux region of France called: "Cannelé de Bordeaux".

Item #	Ø"	H"	Wt oz.
340415	1 3/8	1 3/8	1
340416	1 3/4	1 3/4	2
340417	2 3/16	2 3/16	2



LEARN MORE ABOUT THIS PRODUCT IN OUR CHEF LIFESTYLE BLOG.



ALUMINUM NON-STICK CANNELE MOLD

Thick aluminum with a multi-layer non-stick coating inside and enamelled outside. Pack of 6.

Item #	Ø"	H"	Wt oz.
340411	1 1/3	1 1/3	11
340413	2 1/2	2 1/2	15



EXOPAN STEEL NON-STICK OPEN SAVARIN MOLD

Fine steel with a non-stick coating inside and protective enamel outside. Pack of 12.

Item #	Ø"	H"	Wt
332621	2 3/4	5/8	14 oz.
332622	3 1/8	11/16	1 lb. 1 oz.



EXOPAN STEEL NON-STICK OPEN SAVARIN MOLD

Fine steel with a non-stick coating inside and protective enamel outside.

Item #	Ø"	H"	Capacity
331183	7 1/16	1 5/8	17 oz.
331184	7 7/8	1 2/3	25 oz.
331185	8 2/3	1 3/4	1 qt.
331186	9 1/2	2	1 1/3 qt.



EXOPAN STEEL NON-STICK KUGELHOPF MOLD

Fine steel with a non-stick coating inside and protective enamel outside.

Item #	Ø"	H"	Capacity oz.	Wt oz.
331125	9 1/2	4 3/4	100	15

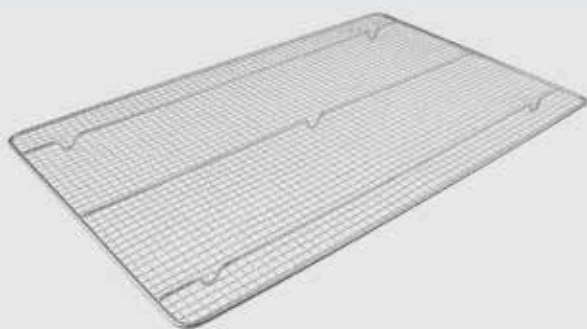

STAINLESS STEEL CONFECTIONARY RACK

Rack only.

Item #	L"	W"	H"
313503	23 1/4	15 1/4	3/4



STAINLESS STEEL BABA MOLD

Perfect for baking fish mousses and flans. Pack of 6.

Item #	Ø"	H"	Capacity oz.	Wt
342476	1 3/4	1 3/4	2	9 oz.
342477	2 3/16	2 3/16	4	12 oz.
342478	2 1/2	2 1/2	6	1 lb. 1 oz.



SEE BOTTLE FOR RUM SPRAYING ON BABA CAKES P. 145



BABA DRAINING BOX

Or candy rack. Consisting of a watertight stainless steel tray with a special grid with narrow mesh 9x9 mm (1/3" x 1/3"). Stainless steel frame with three 6 mm (1/4") cross pieces, 1 mm (3/64") wire, with feet.

Item #	L"	W"	H"
313004	23 3/4	15 3/4	2



EXOPAN STEEL NON-STICK BABA MOLD

Fine steel with a non-stick coating inside and protective enamel outside. Pack of 6.

Item #	Ø"	H"	Capacity oz.	Wt
331591	1 3/4	1 3/4	2	6 oz.
331592	2	2	3	8 oz.
331593	2 3/16	2 3/16	4	10 oz.
331594	2 3/8	2 3/8	5	12 oz.
331595	2 1/2	2 1/2	6	14 oz.
331596	2 3/4	2 3/4	8	1 lb. 1 oz.



EXOGLASS® ROUND BABA MOLD

Pack of 6.

Item #	Ø"	H"	Capacity oz.
345591	1 1/4	1 1/4	2
345592	2	2	2 3/4
345593	2 1/3	2 1/3	3 1/3
345594	2 1/2	2 1/2	4 3/4
345595	2 3/4	2 3/4	7 1/2





MORE INFO ON DIFFERENT TYPES OF MOLDS P. 12-13



EXOPAN STEEL NON-STICK BRIOCHE MOLD

Made of steel, P.T.F.E. coated. The grey colored outside lacquer facilitates diffusion of heat, which gives better baking results. Very little greasing required and easy to clean.



Item #	Ø "	H "	Flutes	
330621	2 3/8	3/4	12	Pack of 25
330622	2 1/2	1	12	Pack of 25
330623	2 3/4	1 1/8	12	Pack of 25
330624	3	1 1/8	10	Pack of 12
330625	3 1/8	1 1/4	10	Pack of 12
330626	3 1/2	1 1/4	10	Pack of 12



EXOPAN STEEL NON-STICK SMALL FLUTE BRIOCHE MOLD

Fine steel with a non-stick coating inside and protective enamel outside.



Item #	Ø "	H "	Pack of	Item #	Ø "	H "	Pack of
330641	2 1/6	5/8	25	330645	3	1	12
330642	2 1/3	3/4	25	330646	3 1/6	1 1/6	12
330643	2 1/2	7/8	25	330647	3 1/2	1 1/4	12
330644	2 3/4	1	25				



EXOPAN STEEL NON-STICK RECTANGULAR FLARED BRIOCHE MOLD

Fine steel with a non-stick coating inside and protective enamel outside.

Item #	L "	W "	H "
332291	9 7/8	3 1/3	1 1/2
332292	11 3/4	3 1/3	1 1/2



EXOGLASS® BRIOCHE MOLD

Made of a single piece of our innovative composite material.



Item #	Ø "	H "	Flutes	
345233	2 3/4	1 1/10	12	Pack of 24
345234	3	1 1/10	10	Pack of 12
345235	3 1/6	1 1/4	10	Pack of 12



EXOPAN STEEL NON-STICK BRIOCHE MOLD

Fine steel with a non-stick coating inside and protective enamel outside. 14 flutes.

Item #	Ø "	H "	Cap. oz.	Item #	Ø "	H "	Cap.
330131	4	1 5/8	2 2/3	330135	7	2 7/8	15 7/8 oz.
330132	4 3/4	1 3/4	5 1/3	330136	7 7/8	3 1/8	1 lb. 7 oz.
330133	5 1/2	2	8 7/8	330137	8 2/3	3 3/8	1 lb. 9 oz.
330134	6 1/3	2 1/2	10 1/2	330138	9 1/2	4	1 lb. 12 oz.



EXAL ALUMINUM NON-STICK BRIOCHE MOLD

Thick aluminum with a multi-layer non-stick coating inside and enamelled outside. Dishwasher safe.

Item #	Ø "	H "	Wt oz.	Flutes	
334024	3	1	-	10	Pack of 6
334025	3 1/8	1 1/4	7	10	Pack of 6
334026	3 1/2	1 1/4	6	10	Pack of 6
334027	4	1 3/8	1	10	Each



- The cake is baked but hollow in the middle.
- Fill it with colourful textures and different flavours!

EXOGLASS® CAKE MOLD WITH FILLABLE MIDDLE
Stainless tube. Optional stainless steel sliding lid.

Item #	L"	W"	H"
345081	5 1/2	3	3
345083	8	3	3
345086	12	3	3
Lid			
346081	5 1/2	3	
346083	8	3	
346086	12	3	



LEARN MORE ABOUT THIS PRODUCT IN OUR CHEF LIFESTYLE BLOG.



EXOGLASS® LOAF MOLD
Made of a single piece of our innovative composite material. Easy and quick removal from mold without risk due to zero heat inertia. Immediate cool down when removed from oven. 5mm (1/5") widening each side.

Item #	L"	W"	H"	Capacity oz.
345071	5 1/2	3 1/6	3 1/6	27
345073	7 1/8	3 1/6	3 1/6	33 7/8
345074	7 7/8	3 1/6	3 1/6	38 7/8
345075	9 7/8	3 1/6	3 1/6	49
345076	11 7/8	3 1/6	3 1/6	59 1/6



EXOGLASS® CONES
Made of a single piece of our innovative composite material. Easy and quick removal from mold without risk due to zero heat inertia. Immediate cool down when removed from oven. Pack of 12.

Item #	Ø"	L"	Wt oz.	Shape
345446	1 1/2	5 1/2	4	Circle
345448	2	5 1/2	6	Ellipse



EXOGLASS® CANNOLI FORM
Made of a single piece of our innovative composite material. Easy and quick removal from mold without risk due to zero heat inertia. Immediate cool down when removed from oven. Pack of 6.

Item #	Ø"	L"
345143	1	3 7/8

EASY ASSEMBLY, EASY TURN-OUT AND PERFECT DESIGN TO CREATE BEAUTIFUL BUCHES



STAINLESS STEEL ROUND BUCHE CAKE MOLD

For the baking of iced, entremets-style yule logs that can be cut to any length, in individual and 4, 6, 8 person portions. The small 1 1/8" (30mm) Ø can be used to make inserts for the 1 7/8" (45mm) or 2 1/3" (60mm) Ø. Can also be used to make roll-cakes or inserts for other preparations.

Item #	Ø"	L"
331052	1 1/8	22 1/4
331054	1 7/8	22 1/4
331056	2 1/3	22 1/4



- Easy to release from mold with the removable U-shaped fittings and the mold's natural widening.
- Assembly facilitated by its design.



Designed by Bruno Pastorelli.



EXOPAN STEEL NON-STICK BUCHE CAKE MOLD

Fine steel with a non-stick coating inside and protective enamel outside. Edge rolled around a copper wire for ultimate heat distribution.

Item #	L"	W"	H"
340623	13 3/4	2 1/3	1 3/4
340624	19 2/3	2 1/3	1 3/4
340625	13 3/4	3 1/6	2 1/6
340626	19 2/3	3 1/6	2 1/6

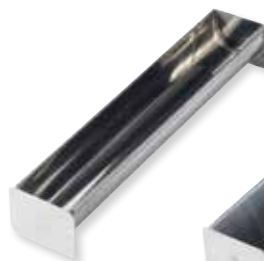

340622



STAINLESS STEEL BUCHE CAKE MOLD

Stainless steel, sealed. Triangle shape.

Item #	L"	W"	H"	Wt	Shape
340622	19 3/4	3 1/2	3	2 lbs.	Triangle
340635	13 3/4	2 3/8	1 3/16	1 lb. 4 oz.	Round
340637	19 3/4	2 3/4	1 3/8	13 oz.	Round
340638	19 3/4	3 1/8	2 1/8	1 lb. 12 oz.	Round



STAINLESS STEEL BUCHE CAKE COMB

This comb is specially shaped to suit the 3 1/8" buche mold and helps to make a mousse-based or ice based double flavored buche that looks perfect when cut.



Item #	Wt oz.
341629	2



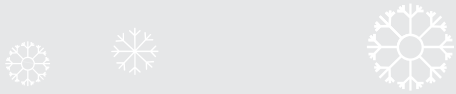

BUCHE CAKE DECORATION KIT

Assembly kit for buche cakes with built-in textured decoration. The kit includes a basic mold and a textured mat to insert into the buche cake mold to create a decorative effect after turning out.



FLEXIPAT BUCHE CAKE MOLD
Buche cake mold to create smooth buche cakes.

Item #	L"	W"	H"
339101	11	3 1/3	2 3/4



BUCHE CAKE DECORATION KIT SQUARE PATTERN
Mold 11" x 3 1/3" x 2 3/4" / Decoration mat 10 7/8" x 7 1/4".

Item #
339202



BUCHE CAKE DECORATION KIT 3D
Mold 9" x 3 1/2" x 2 3/4" / Decoration mat 10 7/8" x 7 1/4".

Item #
339205

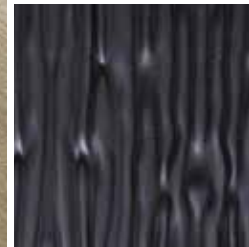

BUCHE CAKE DECORATION KIT WOOD PATTERN
Mold 11" x 3 1/3" x 2 3/4" / Decoration mat 10 7/8" x 7 1/4".

Item #
339201

FOR MAKING EASILY PERFECT DESSERT-STYLE AND ICED LOGS WITH ORIGINAL SHAPES

PVC MOLDS FOR ICE CREAM BUCHES

For making ice cream or dessert logs. Sold in pairs for increased productivity for less handling. Total length 22 1/2" for optimum use of baking trays.



SEMI CIRCULAR SHAPED MINI BUCHE OR INSERT CAKE MOLD

Box of 10 pairs.

Item #	Mold Size "	Overall Size "
362011	22 1/2 x 1 1/2 x 1 1/4	23 1/4 x 4



TRAPEZE SHAPED BUCHE CAKE MOLD

Box of 10 pairs.

Item #	Mold Size "	Overall Size "
362004	22 1/2 x 3 1/4 x 2 1/2	23 1/4 x 7 3/4



RIBBED SHAPED BUCHE CAKE MOLD

Box of 10 pairs.

Item #	Mold Size "	Overall Size "
362003	22 1/2 x 3 1/4 x 2 1/2	23 1/4 x 7 3/4



- Easy to turn out after freezing.
- Storage of 4 logs per 23 3/4" x 15 3/4" tray or grid optimizing storage.



SEMI CIRCULAR SHAPED BUCHE CAKE MOLD
Box of 10 pairs.

Item #	Mold Size "	Overall Size "
362001	22 1/2 x 3 1/4 x 2 1/2	23 1/4 x 7 3/4



EXOPAN STEEL NON-STICK SPRING FORM MOLD

Fine steel with a non-stick coating inside and protective enamel outside.

Removable mold with hinges and 2 interchangeable bottoms: 1 flat and 1 rosary shaped bottom with central chimney.



Item #	Ø"	H"
340215	9 1/2	2 1/2
340216	10	2 1/2
340217	11	2 1/2



EXOPAN STEEL NON-STICK ROSARY MOLD

For cream desserts, ice creams etc. beautiful presentation, easy to cut.

Item #	Ø"	H"	Capacity
332282	6 1/3	2	25 1/3 oz.
332283	7 1/16	2 1/6	1 qt.



STAINLESS STEEL SPONGE CAKE PAN

For biscuits, flans, rice cakes, etc. Straight edges.

Item #	L"	W"	H"	Wt
340305	23 1/4	15 1/4	2 1/4	1 lb. 4 oz.



EXOPAN STEEL NON-STICK SPONGE CAKE PAN

Fine steel with a non-stick coating inside and protective enamel outside. Edge rolled around a copper wire for ultimate heat distribution.

Item #	L"	W"	H"
331311	11 7/8	7 7/8	1 3/8
331312	13 3/4	9 7/8	1 3/8
331313	15 3/4	11 7/8	1 3/8



EXOPAN STEEL NON-STICK SQUARE CAKE PAN

Fine steel with a non-stick coating inside and protective enamel outside. Edge rolled around a copper wire for ultimate heat distribution.

Item #	L"	H"
331664	7 3/4	2
331666	9 1/2	2

EXOPAN TART AND CAKE MOLDS

Fine steel with a non-stick coating inside and protective enamel outside. Ideal for cooking pastry, EXOPAN combines the quality of cooking in tinplate with the simplicity of use of a non-stick surface.



- The fineness of the steel contributes to developing the color of the products.
- Simply wipe clean inside and outside.



EXOPAN STEEL NON-STICK ROUND CAKE MOLD

For individual quiches or tartlets.
Plain cake pan, rolled edges.

Item #	Ø"	H"	Item #	Ø"	H"
331204	6 1/4	1 1/2	331209	10/14	1 3/4
331205	7 1/8	1 1/6	331211	11 7/8	1 7/8
331206	7 7/8	1 1/2	331213	13 1/3	2
331208	9 1/2	1 3/4			



EXOPAN STEEL NON-STICK FLUTED TARTLET MOLD

Products can be frozen directly in the mold. Pack of 12.

Item #	Ø"	H"	Wt
331611	3 3/8	5/8	15 oz.
331612	3 3/4	5/8	1 lb. 4 oz.
331613	4 1/8	3/4	1 lb. 7 oz.



EXOPAN STEEL NON-STICK FRESH FRUITS TART MOLD
This tart mold has a special shape: the bottom is raised in the center, producing a special shaped shell with an indentation. Invert the shell and fill with cream and fresh fruits.

Item #	Ø"	H"	Wt oz.
332233	8 5/8	1	8
332235	10 1/4	1	10



GREATER HEIGHT = INCREASED GARNISH CAPACITY



EXOPAN STEEL NON-STICK CAKE MOLD

Item #	Ø"	H"
331151	4	1 1/6



EXOPAN STEEL NON-STICK CAKE OR QUICHE MOLD

Heavy duty for tarts or quiches.

Item #	Ø"	H"	Wt	
331731	2 3/8	11/16	1 lb. 4 oz.	Pack of 25
331733	2 3/4	11/16	1 lb. 10 oz.	Pack of 25
331734	3	11/16	1 lb. 10 oz.	Pack of 12
331735	3 1/8	11/16	1 lb.	Pack of 12
331737	3 1/2	3/4	1 lb. 3 oz.	Pack of 12
331738	3 3/4	3/4	1 lb. 5 oz.	Pack of 12
331739	4	13/16	1 lb. 8 oz.	Pack of 12



EXOPAN STEEL NON-STICK TART MOLD

1. PLAIN

Item #	Ø"	H"	Wt oz.
332252	4 3/4	13/16	3
332254	6 1/4	7/8	4
332256	7 7/8	7/8	6

2. FLUTED

Item #	Ø"	H"	Wt oz.	Item #	Ø"	H"	Wt oz.
332211	6 1/4	3/4	4	332215	9 1/2	1	8
332213	7 7/8	1	6	332216	10 1/4	1	10
332214	8 5/8	1	7	332217	11	1	10



EXOPAN STEEL NON-STICK FLUTED SPONGE CAKE MOLD WITH REMOVABLE BOTTOM

Item #	Ø"	H"
331811	4 3/4	3/4
331812	5 1/2	7/8
331813	6 1/3	1 1/16
331815	7 7/8	1 1/6
331817	9 1/2	1 1/6



EXOPAN STEEL NON-STICK FLUTED TARTLET MOLD WITH REMOVABLE BOTTOM

Item #	Ø"	H"
331682	7 7/8	1 3/4
331683	9	1 3/4
331684	9 7/8	1 7/8
331685	11	2



EXOPAN STEEL NON-STICK FLUTED TART MOLD WITH REMOVABLE BOTTOM

Item #	Ø"	H"	Wt oz.
332221	6 1/3	3/4	5
332222	7 1/16	3/4	6
332223	7 7/8	1	7
332225	9 1/2	1	10
332227	11	1	13
332228	11 3/4	1	15



GREAT WITH OVAL FLUTED CUTTER! SEE P. 77



EXOGLASS® OBLONG TARTLET MOLD

Pack of 12.

Item #	L"	W"	H"	Wt
345202	4 1/2	2 3/4	3/4	1 lb. 1 oz.



EXAL ALUMINUM NON-STICK FLUTED TARTLET MOLD

Thick aluminum with a multi-layer non-stick coating inside and enamelled outside.

Item #	Ø"	H"	Wt oz.	
334101	3 3/8	5/8	12	Pack of 12
334103	4 1/8	3/4	9	Pack of 6



ALUMINUM NON-STICK PLAIN HIGH-SIDE CAKE MOLD

Thick aluminum with a multi-layer non-stick coating inside and enamelled outside.

Item #	Ø"	H"	Wt oz.
334110	4	1 3/16	2
334112	4 3/4	1 1/4	4
334124	9 1/2	1 3/4	8
334128	11	1 3/4	8



EXAL ALUMINUM NON-STICK PLAIN CAKE MOLD

Thick aluminum with a multi-layer non-stick coating inside and enamelled outside. Pack of 12.

Item #	Ø"	H"	Wt
334177	4	3/4	1 lb. 2 oz.



EXAL ALUMINUM NON-STICK FLUTED QUICHE MOLD

Item #	Ø"	H"	
334180	2 1/3	3/8	Pack of 25
334185	3 1/6	1/2	Pack of 25
334190	4	11/16	Pack of 12
334191	4 1/3	3/4	Pack of 12
334192	4 3/4	3/4	Each



With the kind participation of FERRANDI

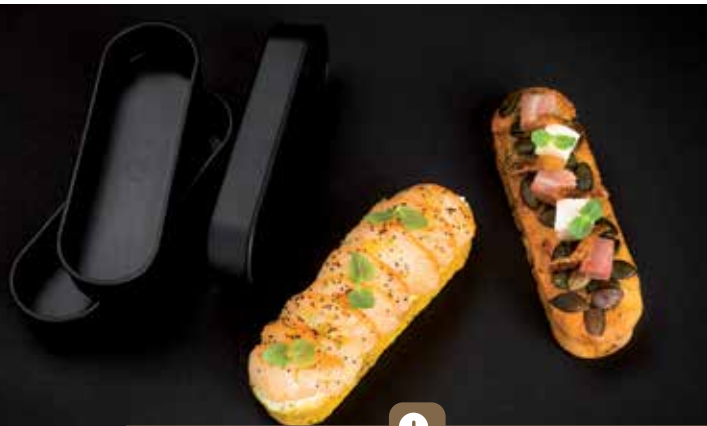

- Elongated shape, suitable for snacking on the move
- Made of composite material suitable for both savory and sweet creations.
- Innovative
- Super Heat Resistant
- Non-Deformable
- Non-Stick
- Long Lasting
- Stackable.

NEW!

EXOGLASS® TARTLET OVAL MOLD

Pack of 48.

Item #	L"	W"	H"
345120	5 1/8	1 1/2	3/4



NO BURNT EDGES



NEW!

EXOGLASS® OVAL CAKE MOLD

Item #	L"	W"	H"	Wt oz.
345078	7	1 3/4	1 3/4	3
345079	8 1/4	2 1/6	2 1/6	5 1/3



EXOGLASS® FLUTED ROUND TARTLET MOLD

Pack of 12.

Item #	Ø"	H"
345656	3 1/6	1/3
345657	3 1/2	5/8
345658	4	3/4
345659	4 1/3	3/4

EXOGLASS® PASTRY MOLDS

Made of an innovative composite material suitable for both savory and sweet creations. Performance and output in terms of cooking make these EXOGLASS® molds the perfect general-purpose product.



- Extra heat resistancy: usable from -4°F to 482°F.
- Non-deformable & long lasting.
- Natural non-stick surface for easy removal & in most cases: no greasing is necessary.
- Dishwasher safe.



NEW!

EXOGLASS® QUICHE MOLD

Rigid form, straight edge, easy to line, dough gets baked uniformly.

Item #	Ø"	H"	
345106	2 3/4	0 7/10	Box of 50
345108	3 1/6	3/4	Pack of 50
345109	3 1/2	3/4	Pack of 12
345110	4	3/4	Pack of 12
345111	4 1/3	3/4	Pack of 12
345112	4 3/4	3/4	Pack of 12
345113	3 1/2	0 4/5	Box of 50
345118	3 1/10	0 4/5	Blister of 10



EXOGLASS® INDIVIDUAL DEEP TARTLET MOLD

Pack of 12.

Item #	Ø"	H"	
345151	4	1 1/4	Fluted
345201	4	1 1/4	Plain



EXOPAN STEEL NON-STICK PLAIN ROUND DEEP TARTLET MOLD

Made of steel with non-stick finish inside and outside.

Item #	Ø"	H"	Shape
332691	1 3/4	6/16	Pack of 25
332692	2	6/13	Pack of 25
332693	2 1/6	7/13	Pack of 25
332694	2 1/3	8/13	Pack of 25
332695	2 1/2	8/13	Pack of 25



EXOPAN STEEL NON-STICK FLUTED TARTLET MOLD

For individual quiches or tartlets.

Item #	Ø"	H"	Shape
332651	2 1/3	3/8	Pack of 25
332657	3 1/2	5/8	Pack of 12
332658	4	11/16	Pack of 12
332659	4 3/8	3/4	Pack of 12



EXOPAN STEEL NON-STICK PLAIN ROUND TARTLET MOLD

Made of steel with non-stick finish inside and outside.

Item #	Ø"	H"	Shape
332671	1 3/4	5/13	Pack of 25
332672	2	5/13	Pack of 25
332676	2 3/4	3/8	Pack of 25
332680	3 1/2	1/2	Pack of 12
332681	4	5/8	Pack of 12



EXOGLASS® PLAIN ROUND TARTLET MOLD

Item #	Ø"	H"	Shape
345676	2 3/4	3/8	Pack of 24
345678	3 1/6	15/32	Pack of 24
345680	3 1/2	1/2	Pack of 12
345681	4	5/8	Pack of 12



EXOPAN STEEL NON-STICK RECTANGULAR TART MOLD
 Fine steel with a non-stick coating inside and protective enamel outside. Pack of 25.

Item #	L"	W"	H"	Wt
331602	3 3/4	1 7/8	7/16	1 lb. 5 oz.



BOX OF PETIT FOUR MOLDS

To shape small desserts or appetizers.
 From mini quiches and fruit tartlets to mini crèmes brûlées.
 Non-stick. Each box contains 10 different shapes.

Item #	Wt
332001	1 lb. 2 oz. 50 per box



EXOPAN STEEL NON-STICK RAMEKIN MOLD
 To bake individual servings of dessert or entree souffle and mousse.

Item #	Ø"	H"	
332602	2 3/8	1	Pack of 6
332604	3 1/2	1 3/8	Pack of 2



DISPOSABLE MUFFIN / CUPCAKE MOLDS

Made of aluminum. Pack of 100.

Item #	Ø"
361212	2 7/8



STAINLESS STEEL CHARLOTTE MOLD
 Bucket shaped mold with two handles for easy release and assembly. Create eye catching Charlottes and puddings.

Item #	Ø"	H"	Wt	Lid
341421	2 3/4	1 3/4	5 oz.	Yes
341422	4	2 3/8	6 oz.	No
341423	4 3/4	2 3/4	8 oz.	No
341427	7 7/8	4 3/8	1 lb. 5 oz.	No



CROQUEMBOUCHE MOLD
 Pastry cone for assembly of cream puff balls into a croquembouche pyramid. Made of stainless steel. Seamless and hollow.

Item #	Ø"	H"	Wt
340463	9 1/4	13 3/4	15 oz.
340464	10	15 3/4	1 lb. 3 oz.
340466	11 7/8	19 5/8	1 lb. 14 oz.
340467	13 3/4	23 5/8	3 lbs. 7 oz.



© Rina Nurra - Ferrandi Pâtisserie



© Maria Mikulasova/Jérôme Vilette



HEMISPHERE MOLD

Set of 3 hemispheres with base. Use to mold chocolate domes and ice cream bombes. Made of rigid food grade polymer.

Item #	Ø"
351001	5 1/2, 6 1/4, 7



EXOPAN STEEL NON-STICK POMPONNETTE MOLD

Fine steel with a non-stick coating inside and protective enamel outside. Pack of 25.

Item #	Ø"	H"
331803	1 3/5	8/13
331804	1 3/4	9/13
331805	2	11/13
331808	2 1/2	12/13



© Franck Dursin/Jérôme Vilette

HEMISPHERE MOLD

Made of 18/10 stainless steel. To shape and bake.

Item #	Ø"	H"	Wt oz.	Capacity oz.	Shape
340401	2 3/8	1	1	1 5/8	Pack of 6
340402	2 3/4	1 3/8	2	2 3/4	Pack of 6
340403	3 3/16	1 1/2	2	4 3/8	Pack of 6
340404	4 3/4	2 3/8	4	15 1/4	Each
340405	5 1/2	2 5/8	6	22 5/8	Each
340406	6 1/4	3 3/16	8	33 7/8	Each
340407	7 3/32	3 35/64	13 25/32	50 3/4	Each



STAINLESS STEEL FLAN MOLD

Round, plain, very deep mold with edge. Stainless steel. Pack of 6.

Item #	Ø"	H"
342651	2 3/4	1 1/2



EXOPAN STEEL NON STICK PLAIN MEAT PIE MOLD

Fine steel with a non-stick coating inside and protective enamel outside. For pates in crust. Perfect baking is facilitated by the grey lacquer on the exterior.

Item #	L"	W"	H"	Wt
331283	11 3/4	2 3/4	3	1 lb. 7 oz.
331284	13 3/4	3	3 1/3	1 lb. 12 oz.
331286	19 3/4	3 3/8	3 1/2	2 lbs. 5 oz.



EXOPAN STEEL NON-STICK OVAL PATE MOLD

Fine steel with a non-stick coating inside and protective enamel outside.

Item #	L"	W"	H"	Wt oz.
331294	8 1/4	5 1/2	3 1/2	14



EXOPAN STEEL NON-STICK PATE MOLD

Fine steel with a non-stick coating inside and protective enamel outside.

Item #	L"	W"	H"
331274	13 3/4	3	3 1/3



EXOPAN STEEL NON-STICK MINI PATE MOLD

Fine steel with a non-stick coating inside and protective enamel outside.

Item #	L"	W"	H"	Wt oz.
331270	19 3/4	1 9/16	2 3/8	1 lb. 11 oz.



- Extra heat resistance.
- Usable from -4°F to 482°F.
- Non-deformable & long lasting.
- Dishwasher safe.



EXOGLASS® BENT SPATULA

Flexible blade made of an innovative composite material which is non-porous, easy to clean and can be sterilized.

Item #	Overall L"	Blade L"	W"	Wt oz.
112686	17	11 3/4	1 1/2	8



LEARN MORE ABOUT THIS PRODUCT IN OUR CHEF LIFESTYLE BLOG.



OFFSET SPATULA

Stainless steel flexible blade, plastic handle. Dishwasher safe.

Item #	Blade L"	Wt oz.
112670	6 1/4	4
112672	8	4
112674	10 1/4	6
112676	12 1/4	7

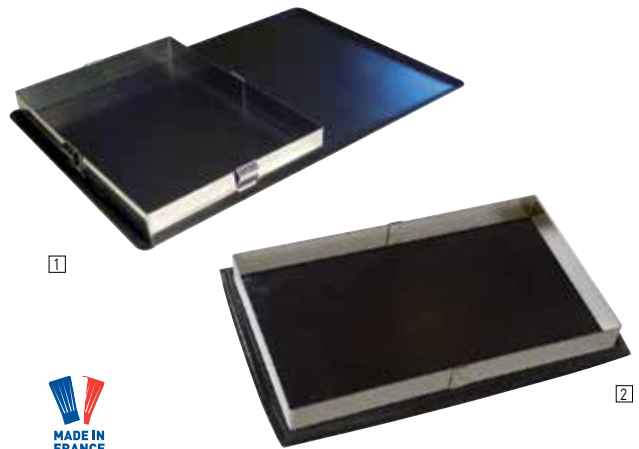

STAINLESS STEEL EXTENDABLE FRAME

Item #	4 Way Standard Size"	Maximum"
371421	11-3/4 x 8 Wide	22 x 14-1/4 Wide
371422	8 x 6 Wide	14-1/4 x 10-2/3 Wide

STAINLESS STEEL FRAME

For assembly of layers of biscuit, coulis or cream, in dessert. Great with Flexipat® sheet (321201).

Item #	L"	W"	H"
371013	21 5/8	14	1 3/4



SPATULA

Stainless steel flexible blade. Molded handle. Dishwasher safe.

Item #	L"
112650	7 7/8
112652	9 7/8
112654	11 7/8
112656	13 7/8

SAVE TIME AND GET PERFECT RESULTS WITH MULTI-LAYERED DESSERTS

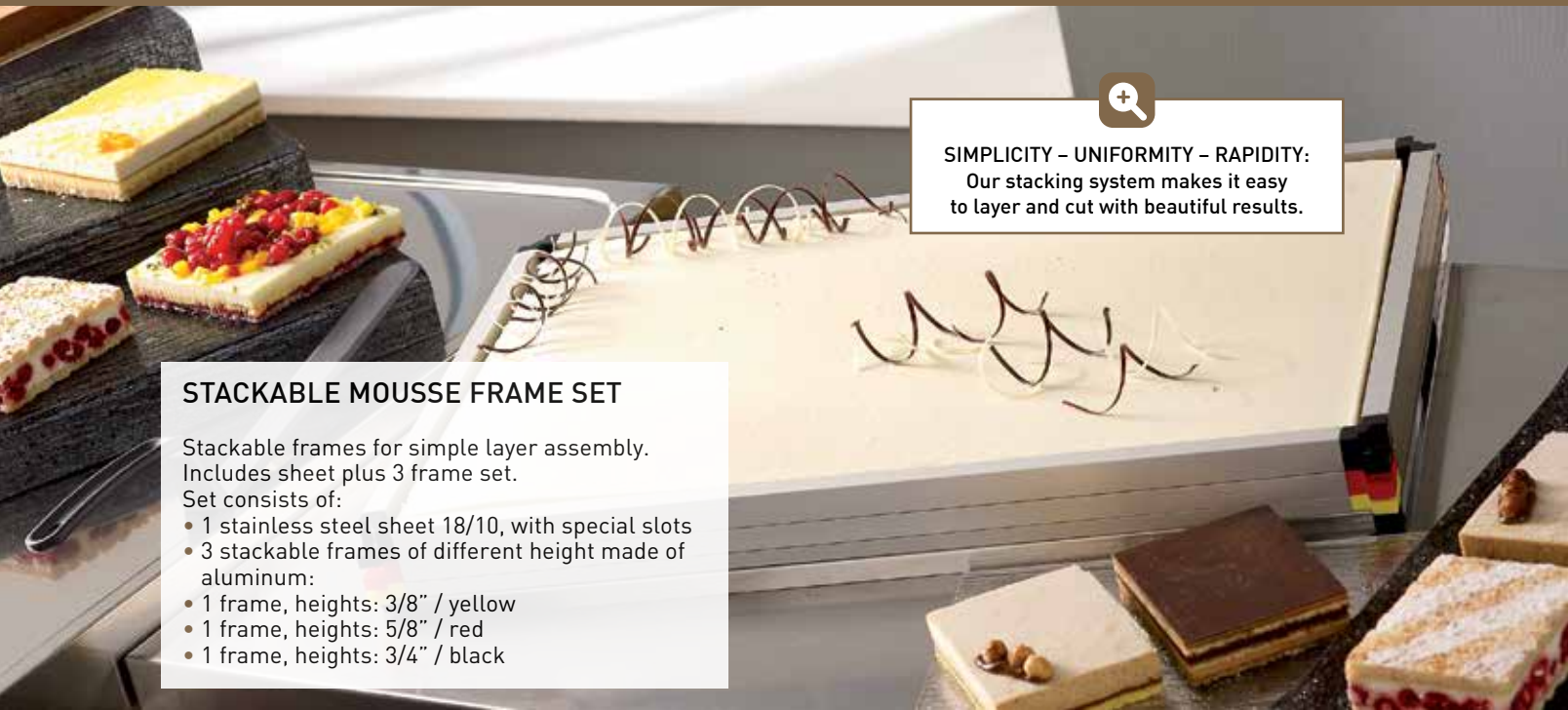

SIMPLICITY – UNIFORMITY – RAPIDITY:
Our stacking system makes it easy to layer and cut with beautiful results.

STACKABLE MOUSSE FRAME SET

Stackable frames for simple layer assembly. Includes sheet plus 3 frame set.

Set consists of:

- 1 stainless steel sheet 18/10, with special slots
- 3 stackable frames of different height made of aluminum:
 - 1 frame, heights: 3/8" / yellow
 - 1 frame, heights: 5/8" / red
 - 1 frame, heights: 3/4" / black

Item #	L"	W"	H"	
370100	23 3/4	15 3/4	-	Sheet + 3 frames set
370107	23 3/4	15 3/4	3/8	Extra yellow sheet
370108	23 3/4	15 3/4	5/8	Extra red sheet
370109	23 3/4	15 3/4	3/4	Extra black sheet
370110	23 3/4	15 3/4	-	Extra special sheet

Item #	L"	W"	H"	
370102	15 3/4	11 7/8	-	Sheet + 3 frames set
370112	15 3/4	11 7/8	3/8	Extra yellow sheet
370113	15 3/4	11 7/8	5/8	Extra red sheet
370114	15 3/4	11 7/8	3/4	Extra black sheet
370115	15 3/4	11 7/8	-	Extra special sheet



SPECIAL STACKING FRAME SET FOR USE WITH GUITAR
Stainless steel sheet and one yellow frame 3/8" (10 mm).

Item #	L"	W"	H"	
370105	13 3/4	13 3/4	1/3	Sheet + 1 frame set
370141	13 3/4	13 3/4	3/8	Extra yellow sheet
370142	13 3/4	13 3/4	5/8	Extra red sheet
370143	13 3/4	13 3/4	3/4	Extra black sheet
370145	13 3/4	13 3/4	-	Extra special sheet

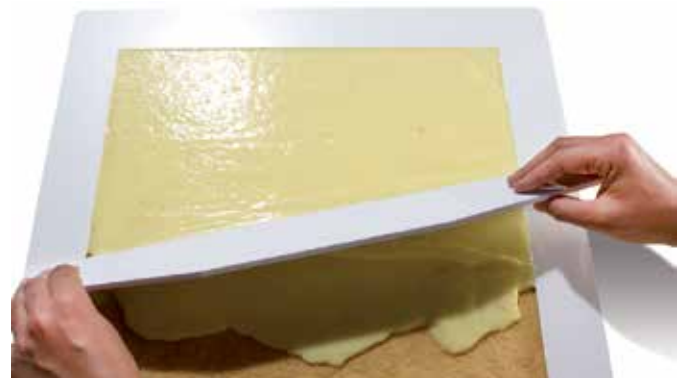

RULER FOR MOUSSE FRAME
Made of food grade plastic.

Item #	L"	W"	Wt oz.
421716	22	3 1/2	7



1 | Place the stainless steel sheet on a flat surface and position the first chosen frame.



2 | Place the stainless steel sheet on a flat surface and position the first chosen frame.



3 | Smooth with ruler as product cools to a hardened base.



4 | Then place the second frame on the first, use another filling and smooth.



5 | Proceed in the same way for the third filling. Freeze the whole set with the sheet if required.

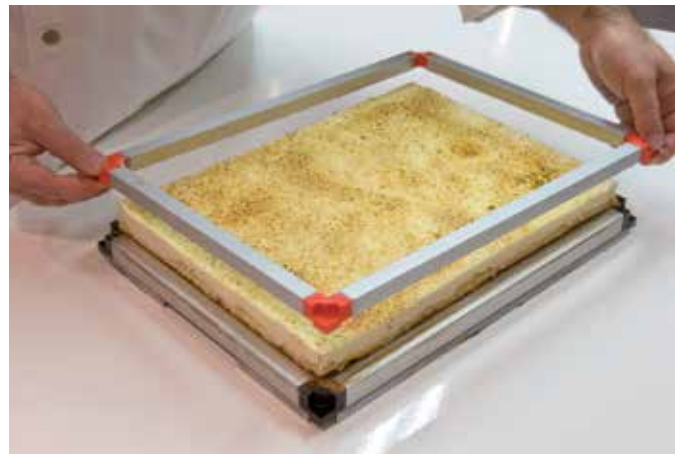

6 | Turn out by removing the frames one by one (do not heat with a torch but use a blow air gun instead).



LEARN MORE ABOUT THIS PRODUCT
IN OUR CHEF LIFESTYLE BLOG.



RECTANGULAR MOUSSE FRAME

Made of stainless steel for assembling logs or desserts. Easy dismantling. Size designed to optimize storage on baking trays.

Item #	L"	W"	H"
371020	22	2 3/4	2 3/4



RECTANGULAR MOUSSE FRAME

Made of stainless steel for assembling logs or desserts. Easy dismantling. Size designed to optimize storage on baking trays.

Item #	L"	W"	H"
371017	14 1/2	3 1/2	1 1/2
371015	22	3 1/2	1 1/2
371016	22 1/2	3 3/4	1 3/4



RECTANGULAR FRAME

Bottomless frame. Heavy duty stainless steel.

Item #	L"	W"	H"	Wt
371003	22 3/4	15	1 3/8	2 lbs. 4 oz.



SQUARE CAKE FRAME

Bottomless frame for crusts, cakes or foccias. Heavy duty, stainless steel.

Item #	L"	H"	Wt
371105	6 5/8	1 3/8	15 oz.
371108	10 3/4	1 3/8	1 lb. 2 oz.
371110	13	1 3/8	1 lb. 9 oz.



ICE CREAM OR CAKE RING

Made of stainless steel. Bottomless for quick and easy removal of cake. Indispensable for layered ice cream cakes. The high sides also make it easy to assemble cakes. H 2 3/8".

Item #	Ø "	Wt oz.	Item #	Ø "	Wt
371801	4 3/4	6	371806	8 3/4	14 oz.
371802	5 1/2	8	371807	9 1/2	15 oz.
371803	6 1/4	9	371808	10 1/4	1 lb. 1 oz.
371804	7 1/8	10	371809	11	1 lb. 6 oz.
371805	7 1/8	11	371810	11 3/4	1 lb. 8 oz.



MOUSSE RING

Made of stainless steel. For layered and sponge cakes. For baking, place mold directly on cookie sheet.

Item #	Ø "	H "	Wt oz.	Item #	Ø "	H "	Wt oz.
371404	4 3/4	1	5	371408	8	1 3/4	8
371405	5 1/2	1 3/4	6	371409	8 3/4	1 3/4	11
371406	6 1/4	1 3/4	6	371410	9 1/2	1 3/4	12
371407	7 1/8	1 3/4	7	371411	10 1/4	1 3/4	13
				371412	11 3/4	1 3/4	1 lb. 8 oz.

PASTRY RIBBON

Made of PVC. Thickness 15 microns, designed to ease the unmolding of your mousses and charlottes or any cold pastry preparation. Not for oven use. Roll of 1100 feet. Place the film inside the ring and then remove the ring without heating up the sides of your cakes for quick and easy unmolding. Delivered with a roll of double faced tape to keep the ribbon in place.

Item #	H "	Wt
960102	1 1/2	4 lbs. 13 oz.
960103	1 3/4	5 lbs. 13 oz.
960104	2 1/3	6 lbs. 13 oz.



© Maria Mikulasova/Jérôme Villette



ENTREMETS RING

Made of stainless steel. Bottomless mold for baking of various simple pastries, such as pastry shell or sponge cake, directly on cookie sheet. Height 1 3/8".

Item #	Ø "	Wt oz.	Item #	Ø "	Wt oz.
371201	4 1/4	4	371207	8 3/4	8
371202	5 1/2	4	371208	9 1/2	9
371203	6	5	371209	10 1/4	10
371204	6 1/4	5	371210	11	13
371205	7 1/8	6	371211	11 3/4	14
371206	8	6			



SEE OFFSET SPATULA P. 43





EXOGLASS® TART RINGS

MULTI-USE: depending on the edge chosen, they can be used for standard fashioning with pre-cut pastry, or levelled fashioning for perfectly-edged tartlets.



- Extra heat resistancy:
- Usable from -4°F to 482°F.
- Non-deformable & long lasting.
- Natural non-stick surface for easy removal
- Dishwasher safe.



LEARN MORE ABOUT THIS PRODUCT IN OUR CHEF LIFESTYLE BLOG.



LEVELLED FASHIONING



STANDARD FASHIONING, FLUTED EDGES



STANDARD FASHIONING, ROLLED EDGES

Pack of 6.

Item #	Ø"	H"	Item #	Ø"	H"
346701	2 1/3	9/13	346705	3 1/6	3/4
346702	2 1/2	2/3	346706	3/4	1 7/8
346703	2 3/4	9/13	346707	3 1/3	3 1/2
346704	3	2/3	346708	4	0/13

EACH

Item #	Ø"	H"	Item #	Ø"	H"
346709	4 3/4	7/8	346714	8 2/3	1
346711	6 1/3	1	346715	9 1/2	1
346712	7 1/16	1	346716	10 1/4	1
346713	7 7/8	1	346717	11	1



STAINLESS STEEL TART RING

Made of stainless steel with rolled rims on both edges.

EACH

Item #	Ø"	H"	Wt oz.
371609	4 3/4	3/4	2
371610	5 1/2	3/4	2
371611	6 1/4	3/4	2
371612	7 1/8	3/4	3
371613	8	3/4	3
371614	8 3/4	3/4	3

EACH

Item #	Ø"	H"	Wt oz.
371615	9 1/2	3/4	3
371616	10 1/4	3/4	3
371617	11	3/4	4
371618	11 7/8	3/4	4
371619	12 1/2	3/4	4
371620	13 3/8	3/4	4

Pack of 6.

Item #	Ø"	W"	Wt oz.
371701	2 3/8	5/8	4
371702	2 1/2	5/8	4
371704	3	5/8	5
371705	3 1/4	5/8	5
371706	3 1/4	5/8	5
371707	3 1/2	5/8	6
371708	3 1/4	3/4	8



ADJUSTABLE TART RING

Made of stainless steel. Bottomless to use directly on cookie sheet or to assemble layered cakes.

Item #	L"	H"	Wt oz.
371420	from 7" to 14 1/8	2	14



PARTY BREAD RING

Made of stainless steel. Bottomless. Bakes high country breads to use as serving bowls for dips. After hollowing, removed bread can be used to make sandwiches to be displayed in crust.

Item #	Ø"	W"	H"
371505	7 7/8	3 9/16	1 lb.

INDIVIDUAL STAINLESS STEEL RING

Referred to as "Nonnettes", in stainless steel for individual small cakes, mousses and entremets.
Pack of 4.



ROUND

Item #	Ø"	H"	Item #	Ø"	H"
375312	2 1/6	1 1/6	375347	3 1/8	1 3/4
375313	2 2/3	1 1/6	375351	2	2
375314	2 3/8	1 1/6	375361	2	2 2/3
375334	2 1/2	1 5/8	375363	2 2/3	2 2/3
375336	3	1 5/8			



HIGH Sold individually

Item #	Ø"	H"	Item #	Ø"	W"	H"
376010	2	3 1/2	376014	1 1/2	1 1/2	1 1/2
376012	3	3 1/2	376015	2 3/8	2 3/8	1 1/4



DIAMOND

Item #	L"	W"	H"
376023	3 1/2	2 1/4	1



HEART

Item #	L"	W"	H"
376005	2 3/4	2 1/4	1 1/4



TEAR

Item #	L"	W"	H"
376021	3 1/4	2	1 1/2



CONVEX TRIANGLE

Item #	L"	H"
376078	2 1/5	1 1/2



SQUARE

Item #	L"	W"	H"
376001	2 1/4	2 1/4	1 3/16



OVAL (1)

Item #	L"	W"	H"
(1) 376039	2 3/4	1 5/8	1 1/6



OVAL HIGH (2)

(2) 376040	3	1 3/4	1 1/6
------------	---	-------	-------



OVAL POINTED

Item #	L"	W"	H"
376041	3 1/2	2	1 1/6



VICHY

Item #	L"	W"	H"
376065	3	1 3/4	1 3/4



RECTANGLE

Item #	L"	W"	H"
376061	3 1/4	1 5/8	1 1/4

PACK DOWN TOOL FOR MOLDS/RINGS

Made of stainless steel. Very useful to pack down ingredients inside the entremets rings in order to obtain nice presentations. Bakelite handle. Can also be used as a cake ejector.



Item #	Ø"	Item #	Ø"
376104	1 1/2	376110	4
376106	2 1/2	376112	4 3/4
376108	3	376114	5 1/2



EXOPAN STEEL NON-STICK MADELEINE SHEET

Fine steel with a non-stick coating inside and protective enamel outside. Our stamped sheets provide a sharp design and shape that is appreciated by specialists. No greasing is needed.

PFOA FREE

+446°F



Item #	Sheet Size	Count	Madeleine Size
310730	14 1/6 x 7 1/2	12	2 3/4
310731	14 x 8	12	3
310732	15 1/2 x 5	20	1 1/2
310739	23 1/2" x 15 3/4"	40	3



FLEXIPAN® MADELEINES MOLD

Item #	Sheet Sz	L"	W"	H"	Cap.	#	Wt
336017	23 3/4 x 15 3/4	3	1 3/4	3/4	1 oz.	40	1 lb.

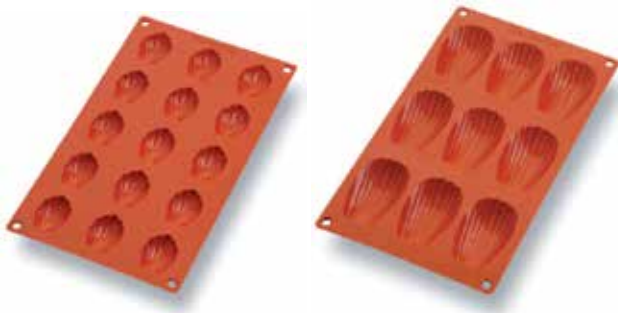

GASTROFLEX® MINI MADELEINE MOLD

Item #	L"	W"	H"	#	Wt oz.
257912	1 3/4	1 5/16	3/8	15	5 oz.

GASTROFLEX® MADELEINE MOLD

Item #	L"	W"	H"	#	Wt oz.
257917	2 7/8	1 7/8	11/16	9	4 oz.



FLEXIPAN® MINI MADELEINES MOLD

Item #	Sheet Sz	L"	W"	Cap.	#	Wt
336046	23 3/4 x 15 3/4	2	1 1/2	1/2 oz.	56	1 lb.



MORE INFO ON GASTROFLEX® MOLDS P. 56



MORE INFO ON FLEXIPAN® MOLDS P. 59

STYLIZED DESIGN AND REPUTATION FOR THE HIGHEST QUALITY SILICONE



SILIKOMART SILICONE MOLDS

Silikomart offers a wide range of stylized and innovative products. Functional, practical and aesthetically pleasing, these products are sure to satisfy the requirements of all those that love to cook. The usage of silicone affords excellent results and notable advantages. Thanks to its resistance, stability and thermic flexibility, all products can be used in temperature ranges between -76°F to 446°F.

Moreover, silicone is an elastic and non-stick material which does not age over time. From the very beginning, Silikomart has focussed on the vision of offering to its clients a product of the utmost quality. For this reason, all production rigorously adheres to the principles of MADE IN ITALY and utilizes the highest quality commercial silicone: 100% liquid platinum silicone. This is a material of the highest quality, perfectly suited for culinary use and completely taste and odor free.

SILIKOMART SILICONE 3D MOLD "KIT TRINITY"

Elegant and harmonious shapes in which the three different creations bond together creating a unique symphony of flavors and colors that will only be revealed once it's cut.



Item #	Ø"	H"	Capacity
238518	7 7/8	2 1/4	1 1/2 qts.

SILIKOMART SILICONE 3D MOLD SQUARE SPHERE

A squared sphere almost looks like a weird word pun, an impossible shape to imagine and to create. Instead, from the perfect fusion of a sphere and a square, the two most used shapes in the pastry.



Item #	L"	W"	H"	Capacity
238519	6 1/3	6 1/3	2 2/3	1 1/4 qts.
238520	2 2/3	2 2/3	1 1/2	3 3/4 oz.



SILIKOMART SILICONE 3D MOLD "VAGUE"

Fine and harmonious waves cover this mold characterized by an elegant round motif designed to create vibrant tasty desserts. Suitable both for baking and blast chiller, VAGUE can be combined with GLOBE mold to make exquisite small pastries to be placed on top of your desserts to create an elegant and sinuous drawing like a stone laid down in the water.

Item #	Ø"	H"	Capacity
258301	7 7/8	1 3/4	37 1/5 oz.



SILIKOMART SILICONE 3D MOLD "VORTEX"

A vortex of taste! VORTEX is a mold with an extremely innovative shape, characterized by a spiral pattern that gives a touch of great originality to the preparations. Extremely practical and handy, VORTEX is suitable both for the blast chiller and the oven.

Item #	Ø"	H"	Capacity
258302	7	1 7/8	32 1/2 oz.

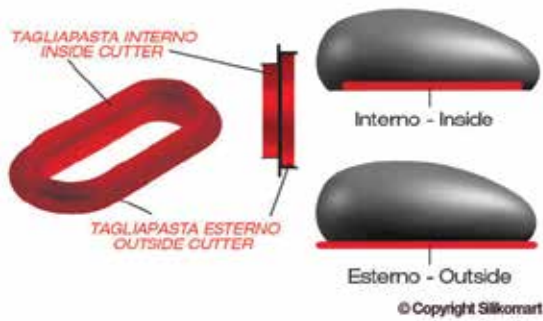

SILIKOMART SILICONE 3D MOLD "ECLIPSE"

Essential, sinuous, with a round shaped surface. Eclipse differs from all the other baking pan molds because it is equipped with two Silicone parts, one of which (A) extremely flexible, apt to further simplify the phase of unmold and to reduce the time of production during the processing.

Item #	Ø"	H"	Capacity
258303	7	1 3/4	33 7/8 oz.

SILIKOMART SILICONE 3D MOLD PILLOW



SILIKOMART SILICONE 3D MOLD "JR. PILLOW"

Item #	L"	W"	H"	Capacity
258304	7 1/2	2 7/8	1 7/8	20 1/3 oz.

SILIKOMART SILICONE 3D MOLD "MR. PILLOW"

Item #	L"	W"	H"	Capacity
258305	8 1/2	3 2/3	2 3/4"	35 1/8 oz.



SILIKOMART SILICONE 3D MOLD "AMORE"

Shapes that will make you fall in love! Characterized by smooth and sinuous lines, the molds AMORE and TI AMO allow you to create romantic heart-shaped creations, to be made in semifreddo or baked version, perfect to be displayed in the shop windows!

Item #	L"	W"	H"	Capacity
258306	5 5/8	5 2/5"	2	20 1/3 oz.



SILIKOMART SILICONE 3D MOLD "TRUFFLES"

Item #	Ø"	H"	Capacity
258314	2	2 1/2	4 oz.



SILIKOMART SILICONE 3D MOLD "TI AMO"

Item #	L"	W"	H"	Capacity
258307	6 2/3	6 1/2	2 1/2	35 1/6 oz.



SILIKOMART SILICONE 3D MOLD "QUENELLE24"

Silikomart Professional presents a new, elegant shape perfect to create 3D sweet or savory quenelle. This mold is conceived and made with maximum care combining beauty and handiness. The new shape is provided with a special and innovative border in the upper part which gives a particular round shape to the base of pastries. This new technology and the flexibility of the high quality guarantee an easy and perfect unmold in every single detail, ensuring perfect results and total fidelity to the shape. An inevitable tool in every laboratory, QUENELLE24 therefore it is suitable for semifreddos but also for ice cream and baked creations.

Item #	L"	W"	H"	Capacity
258313	2 1/2	1 1/6	1 1/10	7/8 oz.



SILIKOMART SILICONE 3D MOLD "AMORINI"

Item #	L"	W"	H"	Capacity"
258312	2 1/2	2 1/2	1 1/2	3 1/4



SILIKOMART SILICONE 3D MOLD "MINI TRUFFLES"

Item #	Ø"	H"	Capacity
258311	1 1/10	1 1/4	2/3 oz.



SILIKOMART SILICONE 3D MOLD "PILLOW"

Item #	L"	W"	H"	Capacity
258310	3 1/5	1 2/3	1 1/4	2 3/4 oz.



SILIKOMART SILICONE 3D MOLD "STONE"

Item #	Ø"	H"	Capacity
258308	2 1/2"	1 1/6	2 7/8 oz.



SILIKOMART SILICONE 3D MOLD "GLOBE"

Item #	Ø"	H"	Capacity
258309	1 3/4	3/4	7/8 oz.



SILIKOMART ZEN

Sinuous and perfect lines, just as those of nature, distinguish ZEN the exclusive shapes by Silikomart Professional characterized by great flexibility and unique design. Beauty and simplicity merge with experience and creativity in these molds, a perfect balance between harmony and proportions.

The single molds come with a functional cutter to make original inserts and/or supporting bases perfectly combinable with ZEN shape.

ZEN molds enable you to make semifreddos, mousses and baked creations with a perfectly delineated shape, like the one of a pebble smoothed by water.

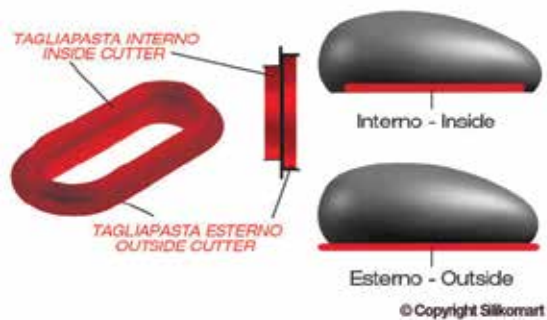

SILIKOMART ZEN100

Item #	L"	W"	H"	Capacity
258315	3 2/5	2 1/2	1 2/5	3 1/3 oz.



SILIKOMART ZEN300

Item #	L"	W"	H"	Capacity
258316	4 7/8	3 1/2	1 3/4	10 1/6 oz.

SILIKOMART ZEN600

Item #	L"	W"	H"	Capacity
258317	6 1/10	4 1/2	2 1/3	20 1/3 oz.

GASTROFLEX® MOLDS

Made of extra strong pure high quality food grade silicone with a non-stick finish that is durable and easy to work with. Single sheet size 11 3/16" x 6 7/8".

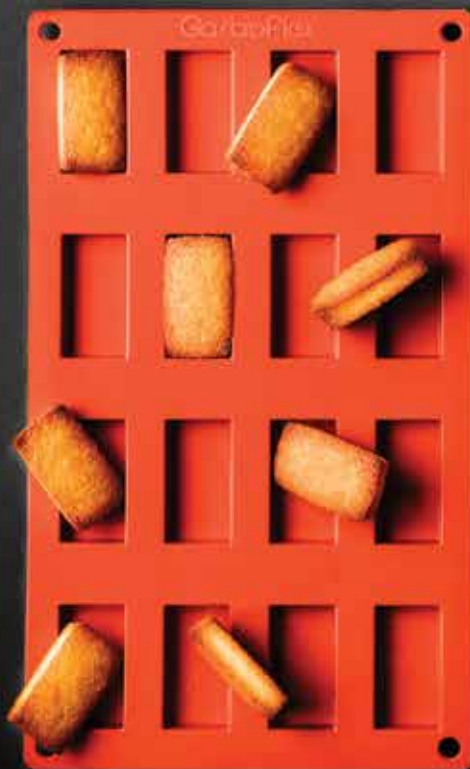
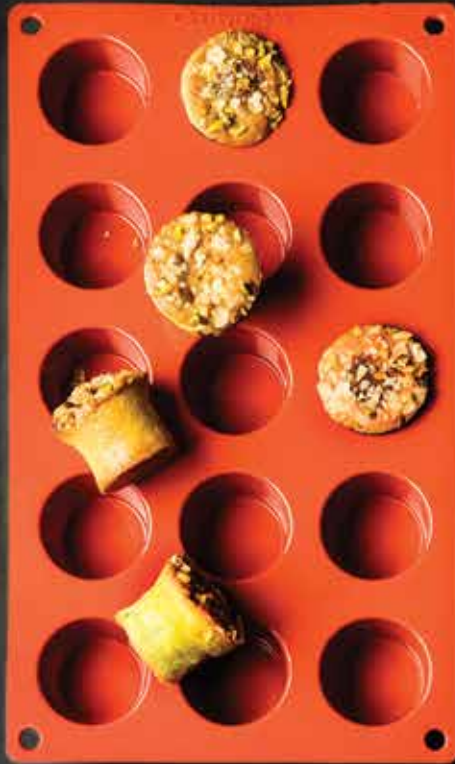



GASTROFLEX® MINI PYRAMID MOLD

Item #	L"	W"	H"	#	Wt oz.
257920	1 3/8	1 3/8	3/4	24	5 oz.

GASTROFLEX® PYRAMID MOLD

Item #	L"	W"	H"	#	Wt oz.
257921	2 3/4	2 3/4	1 1/2	6	5 oz.

GASTROFLEX® MINI MADELEINE MOLD

Item #	L"	W"	H"	#	Wt oz.
257912	1 3/4	1 5/16	3/8	15	5 oz.

GASTROFLEX® MADELEINE MOLD

Item #	L"	W"	H"	#	Wt oz.
257917	2 7/8	1 7/8	1 1/16	9	4 oz.



- Temperature resistance from -40°F to 536°F (from freezer to oven).
- Provides even cooking results.
- Quick and easy to handle.
- No greasing, easy to clean.
- Dishwasher safe.



GASTROFLEX® MINI TARTLET MOLD

Item #	Ø"	H"	#	Wt oz.
257922	1 3/4	3/8	15	4 oz.
257925	2	9/16	15	4 oz.

GASTROFLEX® MINI HALF SPHERE MOLD

Item #	Ø"	H"	#	Wt oz.
257901	1 3/4	3/4	15	5 oz.

GASTROFLEX® HALF SPHERE MOLD

Item #	Ø"	H"	#	Wt oz.
257904	2 3/4	1 3/8	6	5 oz.



GASTROFLEX® FLUTED TART MOLD

Item #	Ø"	H"	#	Wt oz.
257926	2 7/8	3/4	6	4 oz.

GASTROFLEX® SAVARIN MOLD

Item #	Ø"	H"	#	Wt oz.
257928	2 9/16	3/4	6	4 oz.



GASTROFLEX® TATIN MOLD

Item #	Ø"	H"	#	Wt oz.
257930	3	1	6	5 oz.



GASTROFLEX® MINI KUGELHOPF MOLD

Item #	Ø"	H"	#	Wt oz.
257931	2 7/8	1 1/2	6	4 oz.



GASTROFLEX® MINI MUFFIN / CUPCAKE MOLD

Item #	Ø"	H"	#	Wt oz.
257914	1 3/4	1 13/16	15	6 oz.



GASTROFLEX® MUFFIN / CUPCAKE MOLD

Item #	Ø"	H"	#	Wt oz.
257915	2 3/4	1 1/2	6	5 oz.



GASTROFLEX® ROUND PETIT-FOURS MOLD

Item #	Ø"	H"	#
257916	1 1/2	3/4	15



GASTROFLEX® MINI CANNELE MOLD

Item #	Ø"	H"	#	Wt oz.
257990	1 3/8	1 3/8	18	6



GASTROFLEX® MINI CAKES MOLD

Item #	L"	W"	H"	#	Wt oz.
257985	2 3/4	1 1/4	1 1/4	12	4



GASTROFLEX® BRIOCHE MOLD

Item #	Ø"	H"	#	Wt oz.
257905	2 1/16	1 3/16	9	5



DURABLE, LONG-LASTING WITH EXCEPTIONAL NON-STICK PROPERTIES

FLEXIPAN MOLDS

Made of a durable food grade silicone based woven fabric. It is laminated and rubberized which confers unequaled solidness and longevity, along with exceptional non-stick properties, without any greasing. Suitable for both savory and sweet creations.

Tips: Do not fold and do not cut.
Store flat upside down on racks or plates.



EXTRA HEAT RESISTANCY:

- USABLE from -40°F to + 500°F.
- Can be used 2000 to 3000 times.
- NO GREASING is necessary.
- EASY TO CLEAN.
- MAKE INSERTS in your pastries using the same shapes available in different sizes.

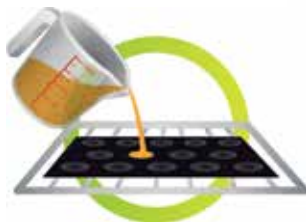
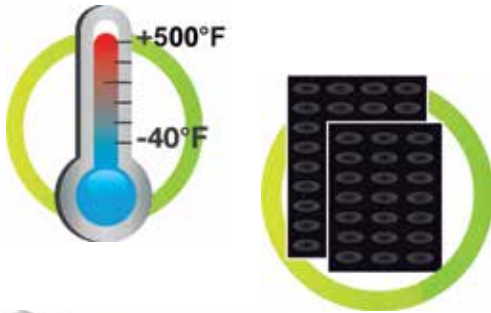

Place the mat on a perforated plate or rack before handling.



Wash with a soft sponge.
Use neutral PH detergent (pH = 7).
Dry in an oven set at 100°C for 10 mins.

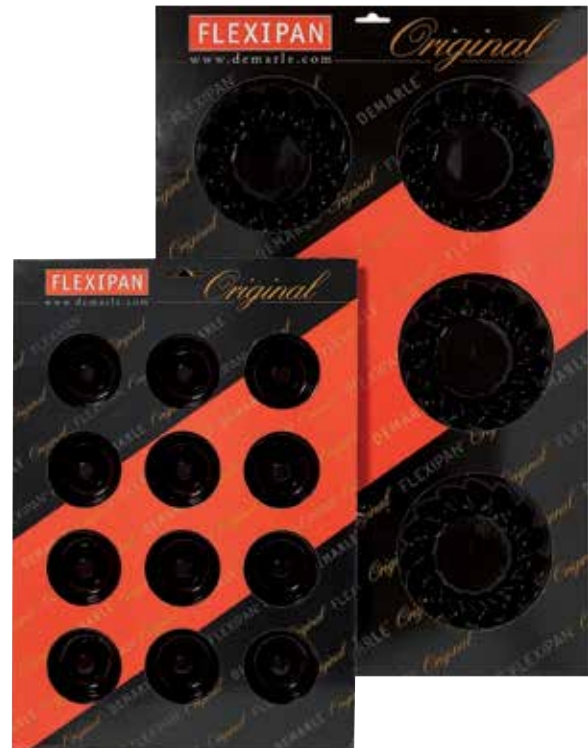



VOLCANOS MOLD

Item #	Sheet Sz	Ø"	H"	Cap.	#
336094	23 3/4 x 15 3/4	2 3/4	1 1/3	2 3/4 oz.	18



HALF-CYLINDERS MOLD

Item #	Sheet Sz	L"	W"	H"	Cap.	#
336170	23 3/4" x 15 3/4	3 1/3	2/3	5/8	2/3 oz.	48



MINI VOLCANOS MOLD

Item #	Sheet Sz	Ø"	H"	Cap.	#
336095	23 3/4 x 15 3/4	1 2/3	3/4	2 3/4 oz.	54



SMALL BARS WITH CAVITY MOLD

Item #	Sheet Sz	Cap.	#
336107	23 3/4 x 15 3/4	2 1/3 oz.	24



OVALS MOLD

Item #	Sheet Sz	L"	W"	H"	Cap.	#
336074	23 3/4 x 15 3/4	2 1/4	1 1/3	1/2	5/8 oz.	64
336075	23 3/4 x 15 3/4	2 3/4	2	1	7/8 oz.	30



FLOWERS MOLD

Item #	Sheet Sz	Ø"	H"	Cap.	#
336116	23 3/4 x 15 3/4	3	3/4	2 3/4 oz.	24



CROWN MUFFINS MOLD

Item #	Sheet Sz	Ø"	H"	Cap.	#	Wt
336044	21" x 13	2 3/4	1 2/3	3 oz.	15	1 lb.



DARIOLES MOLD

Item #	Sheet Sz	Ø"	H"	Cap.	#
336160	23 3/4 x 15 3/4	2 1/2"	2 1/6	4 1/3 oz.	15

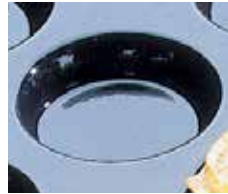

MEDALLIONS MOLD

Item #	Sheet Sz	Ø"	H"	Cap.	#	Wt
336033	23 3/4 x 1 1/8	1/3	1 1/8	1/6 oz.	96	1 lb.

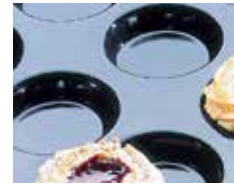

FLORENTINS MOLD

Item #	Sheet Sz	Ø"	H"	Cap.	#	Wt
336024	23 3/4 x 15 3/4	4	2/3	4 3/4 oz.	15	1 lb.
336018	23 3/4 x 15 3/4	2	6/13	1 oz.	40	1 lb.



MINI-QUICHE TARTLETS MOLD

Item #	Sheet Sz	Ø"	H"	Cap.	#	Wt
336007	23 3/4 x 15 3/4	1 3/4	3/8	1/3 oz	60	5 oz.



BRIOCHE MOLD

Item #	Sheet Sz	Ø"	H"	Cap.	#	Wt
336063	23 3/4 x 15 3/4	3 1/8	1 1/4	3 1/2 oz.	24	18 oz.

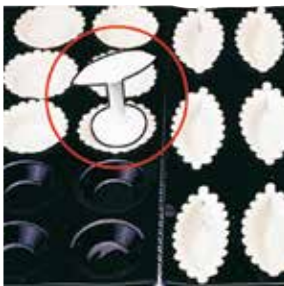

DOUBLE SIDED MOLDING STAMP

For plain tartlet Ø 1 3/4" and 1 11/12" and boat mold.
Works with FLEXIPAN®, EXOPAN or EXAL or GASTROFLEX®.
White polypropylen.

Item #	Wt
140102	1 oz



TATIN APPLE TARTS / QUICHES MOLD

Item #	Sheet Sz	Ø"	H"	Cap.	#	Wt
336049	23 3/4 x 15 3/4	4	1 1/4	8 oz	12	1 lb. 1 oz.
336020	23 3/4 x 15 3/4	4 1/8	1 1/2	10 oz.	12	1 lb.

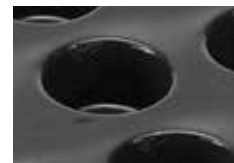

MINI-MUFFIN / CUPCAKE MOLD

Item #	Sheet Sz	Ø"	H"	Cap.	#	Wt
336023	23 3/4 x 15 3/4	2	1	2 oz.	40	15 oz.

MUFFIN / CUPCAKE MOLD

Item #	Sheet Sz	Ø"	H"	Cap.	#	Wt
336019	23 3/4 x 15 3/4	2 3/4	2 3/16	4 1/4 oz.	24	1 lb. 4 oz.
336045	23 3/4 x 15 3/4	3	1 1/2	3 7/8 oz.	24	8 oz.

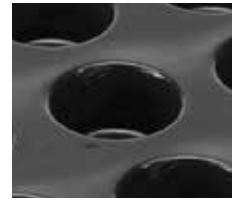

MINI-CYLINDERS MOLD

Item #	Sheet Sz	Ø"	H"	Cap.	#	Wt
336040	23 3/4 x 15 3/4	1 1/2	1/2	1/2 oz	54	15 oz.
336027	23 3/4 x 15 3/4	1 1/2	3/4	3/4 oz.	54	1 lb.



MADELEINES MOLD

Item #	Sheet Sz	L"	W"	H"	Cap.	#	Wt
336017	23 3/4 x 15 3/4	3	1 3/4	3/4	1 oz.	40	1 lb.



HALF-SPHERES MOLD

Item #	Sheet Sz	Ø"	H"	Cap.	#	Wt
336001	23 3/4 x 15 3/4	1 3/8	5/8	1/4 oz.	70	13 oz.

MINI HALF-SPHERES MOLD

Item #	Sheet Sz	Ø"	H"	Cap.	#	Wt
336151	23 3/4 x 15 3/4	1	1/2	1/4 oz.	96	15 oz.
336056	23 3/4 x 15 3/4	2 1/4	1 1/4	1 3/4 oz.	28	15 oz.

SMALL HALF-SPHERES MOLD

Item #	Sheet Sz	Ø"	H"	Cap.	#	Wt
336002	23 3/4 x 15 3/4	1 5/8	3/4	2/3 oz.	48	13 oz.

REGULAR HALF-SPHERES MOLD

Item #	Sheet Sz	Ø"	H"	Cap.	#	Wt
336003	23 3/4 x 15 3/4	2 3/4	1 5/8	4 oz.	24	13 oz.

HALF-SPHERES MOLD

Item #	Sheet Sz	Ø"	H"	Cap.	#	Wt
336057	23 3/4 x 15 3/4	3 3/16	1 9/16	4 1/2 oz.	24	15 oz.



MINI MADELEINES MOLD

Item #	Sheet Sz	L"	W"	Cap.	#	Wt
336046	23 3/4 x 15 3/4	2	1 1/2	1/2 oz.	56	1 lb.



CAKES WITH A CAVITY MOLD

Item #	Sheet Sz	L"	W"	H"	Cap.	#	Wt
336105	23 3/4 x 15 3/4	4 3/4	1 1/2	1	3 oz.	24	1 lb.

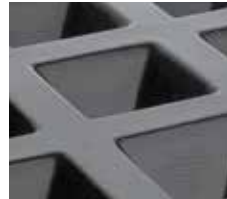

PYRAMID MOLD

Item #	Sheet Sz	Ø "	H "	Cap.	#	Wt
336012	23 3/4 x 15 3/4	1 1/2	7/8	1/2 oz.	54	13 oz.
336013	23 3/4 x 15 3/4	2 3/4	1 5/8	3 oz.	24	13 oz.



CHARLOTTE MOLD

Item #	Sheet Sz	Ø "	H "	Cap.	#	Wt
336090	23 3/4 x 15 3/4	3	1 1/2	3 2/5 oz.	18	1 lb.
336087	23 3/4 x 15 3/4	1 1/3	8/13	1/3 oz.	60	1 lb.

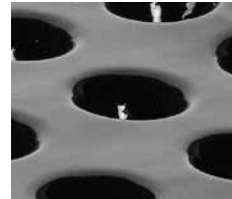

CONES MOLD

Item #	Sheet Sz	Ø "	H "	Cap.	#	Wt
336037	23 3/4 x 15 3/4	2 3/4	2 1/3	2 2/3 oz.	20	1 lb.
336039	23 3/4 x 15 3/4	1 1/4	3/4	1/4 oz.	96	1 lb.



CYLINDERS MOLD

Item #	Sheet Sz	Ø "	H "	Cap.	#	Wt
336005	23 3/4 x 15 3/4	1 1/2	3/4	3/4 oz.	48	14 oz.
336043	23 3/4 x 15 3/4	3 1/4	1 1/5	4 1/2 oz.	15	1 lb.
336006	23 3/4 x 15 3/4	2 1/2	1 5/12	3 oz.	24	1 lb.



BAVAOIS MOLD

Item #	Sheet Sz	Ø "	H "	Cap.	#	Wt
336034	23 3/4 x 15 3/4	3	1 3/8	3 3/8 oz.	18	1 lb.



POMPONETTES MOLD

Item #	Sheet Sz	Ø "	H "	Cap.	#	Wt
336004	23 3/4 x 15 3/4	3	1 3/8	3 3/8 oz.	18	1 lb.



FLEXIPAN CUTTERS

Stainless steel cutters, with reinforced body. Specially designed for cutting biscuits meant to be used as bases for individual cakes formed in Flexipan.



Item #	Designed for	Shape
153046	For molds 336101-3-4	RECTANGULAR
153052	For molds 336135	SQUARE
153190	For molds 336190	EGG



RECTANGULAR CAKE MOLD

Item #	Sheet Sz	L"	W"	H"	Cap.	#	Wt
336101	23 3/4 x 15 3/4	3 1/6	1 1/6	1 1/6	1 7/8 oz.	24	1 lb.
336103	23 3/4 x 15 3/4	3 1/2	1 3/4	1	3 3/4 oz.	25	1 lb.
336104	23 3/4 x 15 3/4	4	2	1 1/8	4 oz.	21	1 lb.



SQUARE SAVARIN MOLD

Item #	Sheet Sz	L"	W"	H"	Cap.	#	Wt
336135	23 3/4 x 15 3/4	2 3/4	2 3/4	1 1/5	3 1/3 oz.	24	1 lb.

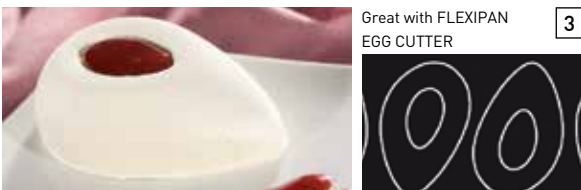

EGGS MOLD

Item #	Sheet Sz	L"	W"	H"	Cap.	#
336190	23 3/4 x 15 3/4	3 3/4	2 1/3	1 1/5	3 1/5 oz.	25



SAVARIN MOLD

Item #	Sheet Sz	Ø"	H"	Cap.	#	Wt
336014	23 3/4 x 15 3/4	1 1/2	1/2	1/3 oz.	60	14 oz.
336015	23 3/4 x 15 3/4	2 7/8	7/8	2 oz.	24	1 lb. 1 oz.



MINI-FINANCIERS MOLD

Item #	Sheet Sz	L"	W"	H"	Cap.	#	Wt
336009	23 3/4 x 15 3/4	2	1	1/2	1/3 oz.	84	15 oz.



FINANCIERS MOLD

Item #	Sheet Sz	L"	W"	H"	Cap.	#	Wt
336010	23 3/4 x 15 3/4	3 1/2	1 7/8	1/2	2 oz.	24	1 lb.



DISCS MOLD

Item #	Sheet Sz	Ø"	H"	Cap.	#	Wt
336030	23 3/4 x 15 3/4	5 3/4	1/2	6 3/4 oz.	6	1 lb. LARGE
336032	23 3/4 x 15 3/4	6 1/2	1/2	8 1/12 oz.	6	1 lb. XL
336022	23 3/4 x 15 3/4	7 1/3	1/2	10 1/6 oz.	6	1 lb. XXL



NEW!

Flexible, new molds come in high-precision shapes and will inspire countless new creations.

Solid silicon, 100% platinum.



- A highly resistant mold.
- Easy turning out.
- Precise, detailed shapes.
- Particularly suited to freezing.



FLEXIBLE CYLINDER MOLD

Item #	Sheet Sz	Capacity	Ø	H"	Cavity	Wt oz.
339114	23" x 15 1/6"	5	2 3/4	1 1/2	24	3 1/2



FLEXIBLE CHIC MOLD

Item #	Sheet Sz	L"	W"	H"	Capacity	Cavity	Wt oz.
339103	23" x 15 1/6"	2 1/3	2 1/3	1 1/6	4 1/3	24	3 1/2



FLEXIBLE DIAMOND MOLD

Item #	Sheet Sz	L"	W"	H"	Capacity	Cavity	Wt oz.
339106	23" x 15 1/6"	2 7/8	2 7/8	1 1/2	3 1/3	24	3 1/2



FLEXIBLE MINI CUBES MOLD

Item #	Sheet Sz	L"	W"	H"	Capacity	Cavity	Wt oz.
339110	23" x 15 1/6"	1 1/6	1 1/6	3/4	1/2	96	3 1/2



FLEXIBLE SPHERE MOLD

Item #	Sheet Sz	Capacity	Cavity	Wt oz.
339210	11 7/8" x 7 7/8"	83 7/8	8	3 1/2

MADE OF SILICONE AERATED KNITTED FIBER GLASS FABRIC: TURN OUT IS PERFECT!

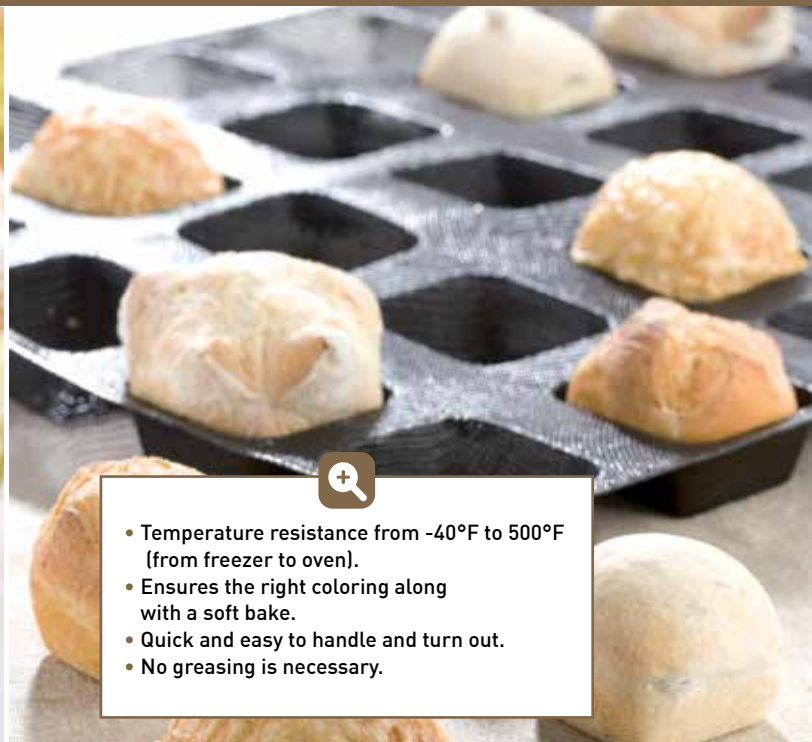

- Temperature resistance from -40°F to 500°F (from freezer to oven).
- Ensures the right coloring along with a soft bake.
- Quick and easy to handle and turn out.
- No greasing is necessary.

SILFORM® MOLDS

Designed in silicone impregnated aerated knitted glass fabric perfectly suitable for baking choux pastry and blind baking of tartlet bases. The circulation of warm air under the mat ensures the right coloring along with a soft bake.

Uniformly-sized choux are obtained on account of the shape cavities adapted for each preparation.

Blind baking of tartlet bases becomes very easy, without having to line or poke the dough or even grease the molds.

We recommend the use of perforated aluminum sheets as baking support.

Just place the shapes cut with an Exoglass® cutter on the Silform® upside down and bake on the sheet for around 15 min at 350°F.

With the heat uniformly spread, the dough is in close contact with the shape and cooks perfectly.

A practical solution to save time Silform® can also be used in a traditional manner on the right side, by lining the dough.



Place the mat on a perforated plate or rack before handling.



Wash with a soft sponge. Use neutral PH detergent (pH = 7). Dry in an oven set at 100°C for 10 mins.



SILFORM® NON-STICK SHEETS FOR PASTRY

Silform® molds are specially designed for choux pastry. Its pre-formed molds make calibrating and shaping choux pastry easy. No need to glaze or score the choux pastry. Once baked, the pastries are perfectly even and smooth on top. Silform® non-stick technology makes turning out easy.



CHOUX - PASTRY PUFFS MOLD

Item #	Sheet Sz	Ø "	H "	#
337001	23 3/4 x 15 3/4	2 3/4	1/2	28

SMALL CHOUX - PASTRY PUFFS MOLD

Item #	Sheet Sz	Ø "	H "	#
337000	23 3/4 x 15 3/4	1 1/4	2 1/4	59



ÉCLAIR MOLD

Item #	Sheet Sz	Ø "	H "	#
337002	23 3/4 x 15 3/4	5	1	18

MINI ÉCLAIR MOLD

Item #	Sheet Sz	L "	W "	H "	#
337006	23 3/4 x 15 3/4	2 3/4	1 1/4	1/4	48



PARIS-BREST MOLD

Item #	Sheet Sz	Ø "	H "	#
337004	23 3/4 x 15 3/4	3 1/4	1/2	24

SILFORM® NON-STICK SHEETS FOR BAKERY

Specially designed for bread-making and ideal for baking bread in a range of different shapes. The aerated texture optimises air flow for unparalleled crust and color.



MINI BAGUETTE MOLD

Item #	Sheet Sz	L "	W "	H "	#
337100	23 3/4 x 15 3/4	10 1/4	2 1/2	1 1/4	8



SQUARE HAMBURGERS MOLD

Item #	Sheet Sz	L "	W "	H "	#
337030	23 3/4 x 15 3/4	3 3/4	3 3/4	1	15



BUNS MOLD

Item #	Sheet Sz	Ø "	H "	#
337029	23 3/4 x 15 3/4	4	3/4	15



SANDWICH MOLD

Item #	Sheet Sz	L "	W "	H "	#
337102	23 3/4 x 15 3/4	9 1/2	2 3/4	1 1/2	8



LEARN MORE ABOUT THIS PRODUCT
IN OUR CHEF LIFESTYLE BLOG.



MADE OF A DURABLE FOOD GRADE SILICONE IMPREGNATED KNITTED FIBERGLASS FABRIC



- Heat resistant from -40°F to + 580°F.
- No greasing, releases and sponge cleans easily.
- Replaces parchment paper.
- Reusable between 2,000 to 3,000 times.
- Lays flat by soaking in warm water overnight.
- Microwave safe.



EXOPAT® NON-STICK BAKING MAT

Identical to the SILPAT mat.
Decorated with Matfer's trademark white borders.

Item #	L"	W"	Wt
Fits 18" x 13" sheet			
321005	16 3/8	11 5/8	3 oz.
Fits 26" x 18" sheet			
321004	24 1/2	16 3/8	7 oz.

NOTE: DO NOT CUT OR USE SHARP OBJECTS.



- No greasing is necessary.
- Easy to clean with sponge.
- Heat resistant from 100°F to 580°F.
- For better cooking, please use perforated oven sheet.

SILPAIN NON-STICK BREAD BAKING SHEET

Aerated silicone plated sheet for cooking bread on 23 5/8" x 15 3/4" plates.

Item #	L"	W"
321014	20 1/2	12 1/2
321012	23	15 1/2





Item #	L"	W"	H"
321000	15 3/4	12	6 oz.

SILPAT® NON-STICK MAT

Silicone impregnated knitted glass fabric. Ideally suited as baking sheets for pastries and breads or for confectionary and nougatine related baking.



- Heat resistant from -40°F to 580°F.
- No greasing is needed.
- For best results, use with perforated aluminum sheet or grid.
- Can be used for all types of ovens: ventilated, deck type, steam, microwave and in deep freezers.
- Easy cleaning with the help of a sponge.

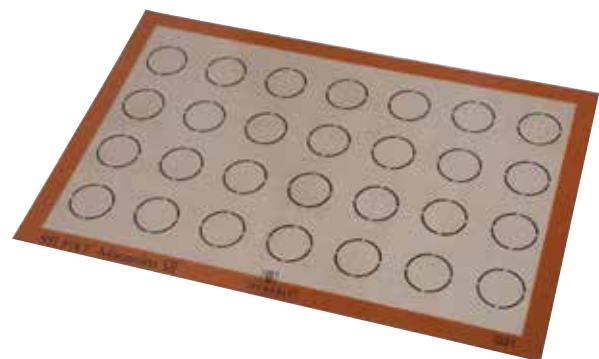

SILPAT® NON-STICK MAT FOR MACAROONS
With 1 5/12" circle markings for even arrangement. 63 staggered markings (9 x 7).

Item #	L"	W"
321008	23	15 1/6



SEE PYRAMID MACAROONS DISPLAY P. 209

- Practical: No need for cleaning products for washing baking sheets.
- Time saving: Eliminates the baking sheet cleaning process.
- No need to grease.
- Eco friendly.
- Easy to handle.
- Low investment costs.
- Cardboard dispenser box of 500 sheets.
- Multiple uses.

MATFER BAKING PAPER

Silicone double-faced baking paper. For cooking, frying, freezing, decorating, storing.

SPECIAL FREEZING

© Juliette Pradels - Jérôme Villette



ECOPAP BAKING PAPER

Unbleached brown paper, combining ecology with economy. Density 39 g/m². Non-stick silicone coating on both sides. Reusable up to 7-8 times depending on conditions of use. Suitable for all cakes and pastries. The paper pulp used to make our baking paper is from forests that are managed in accordance with the principles of sustainable development. Box of 500 sheets.

Item #	Density	L"	W"	Wt
320211	39 g/m ²	23 3/4	15 3/4	12 lbs. 2 oz

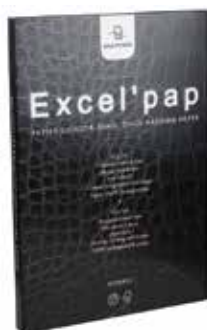

FOR SWEET PRODUCTS

EXCEL'PAP BAKING PAPER

Double-sided silicone paper. Superior quality, suitable for baking delicate products such as tuiles, joconde cake, succès, macaroons, etc. REUSABLE APPROX 10 TIMES.

Item #	Density	L"	W"	Wt
320200	45 g/m ²	23 3/4	15 3/4	



EXOPAP BAKING PAPER

Silicone double-faced baking paper. Density 41 g/m². Can be used 2 or 3 times on each side. Heat resistant to 600°F. Double sided (both sides can be used, non-stick). For cooking, frying, freezing, decorating, storing, interleaving. Can be reused based on the type of baking. Ready to use sheets. Packaged in the form of dispenser cartons. Box of 500 sheets.



Item #	Density	L"	W"	Wt
320201	41 g/m ²	23 3/4	15 3/4	12 lbs. 2 oz.
320231	41 g/m ²	22 2/3	14 3/4	9 lbs. 12 oz.

NEW!

- All our papers ARE 100% biodegradable.
- They are made exclusively with natural materials.
- They contain no chemicals or other foreign substances.
- They contain no fluorinated chemicals.
- They are made exclusively using resources from sustainable forests.





FLEXIPAT® SHEET

The FLEXIPAT® has all the advantages of the FLEXIPAN® with its flexibility, support and non-stick properties, which makes turn out easy. It is used in a similar manner as the EXOPAT® due to its flatness.

Item #	Sheet Sz	Inner Dimensions
321200	23 3/4 x 15 3/4	L 21 x W 14 x H 3/8
321201	23 3/4 x 15 3/4	L 21 3/4 x W 14 1/4 x H 3/4



- Extra heat resistancy: **USABLE from -40°F to + 500°F.**
- Easy turn out.
- Can be used 2000 to 3000 times.
- No greasing is necessary.
- Easy to clean.
- Ensure constant thickness.

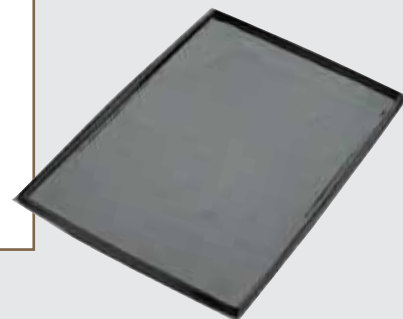

Flexipat features raised edges in its design and it allows FLEXIPAT® to be used in a variety of ways.

- 1 | Spread or pour any type of preparations: fruit jellies, ganaches, coulis, crème brûlée etc.
- 2 | Bake biscuits.
- 3 | Obtain a sheet ready to assemble in frames, without wasting material.
- 4 | Ensure constant thickness.

Mold turn out does not cause any problems because of the flexible and non-stick properties of the FLEXIPAT®. It is very easy maintenance: just dip in soap water and clean with a soft sponge. For drying, place in the oven for 2 to 3 minutes at 212° F."



LEARN MORE ABOUT THIS PRODUCT IN OUR CHEF LIFESTYLE BLOG.



PAPER CLIP "CLIP'PLAC"

Keeps the siliconized paper on plates during cooking in a rotary or forced-air oven. Avoid the sheet sticking with dough and hence the need to clean the plate. Stainless steel spring. 24 clips bag.

Item #	L"	W"
111892	7/8	1/3



MORE ON THIS PRODUCT P. 43



- Dishwasher safe.
- Suitable for temperatures -4° to +185°F.
- Ideal for storing chocolates and for preparing fragile desserts.



SMOOTH, EDGELESS SHEET



Double-sided, ultra rigid and non-deformable melamine resin tray without edges.

Item #	L"	W"	H"
310812	23 3/4	15 3/4	1/4



- Super heat resistant from -4°F to 482°F.
- Non-deformable & long lasting.
- Non-stick.
- Dishwasher safe.

EXOGLASS® BENT SPATULA

Flexible blade made of an innovative composite material which is non-porous, easy to clean and can be sterilized.

Item #	Overall L"	Blade L"	W"	Wt oz.
112686	17	11 3/4	1 1/2	8

Warning: not intended for baking.



ROULPAT MAT

Made of woven silicone and rubberized on both sides. One side has markings for working with dough, while the other side has a non-skid feature needed to roll dough. Ideal for mixing, rolling or beating dough. Create forms or decorations with chocolate, sugar, caramel or nougatine.

Item #	W"	Wt	L"
321023	15	7 oz.	23
321026	18"	10 oz.	26"



- Non-stick protection for black steel and aluminum baking sheets.
- Can be cut to any size.
- Reusable over 1,000 times (depending on care and use).

NON-STICK FIBERGLASS SHEET

Made of food grade fiberglass, thickness 8/100mm.

Item #	L"	W"	
320412	22 1/2	14 1/2	Pack of 6.



- Economical, can be used without baking paper.
- Does not get oxidated.
- Suitable for breads, choux pastry, meringues, puff pastry.
- Greasing not needed in many cases.
- Easy cleaning with dry cloth.



EXAL ALUMINIUM NON-STICK BAKING SHEET

EXAL: aluminum non-stick coating, food grade.

Item #	L"	W"	Rim	Wt
310201	15 3/4	11 7/8	5/8	1 lb. 2 oz.
310202	23 5/8	15 3/4	5/8	2 lbs. 4 oz.
310203	20 7/8	12 3/4	5/8	1 lb. 10 oz.



- Excellent for baking frozen pastry. Insures uniform baking.
- Better baking through consistent air circulation.
- Suitable for breads, choux pastry, meringues, puff pastry.
- Improved non-stick surface for ease in product removal.

EXAL ALUMINIUM NON-STICK EMBOSSED OVEN SHEET

Thick aluminum non-stick with a multi-layer non-stick coating inside and enameled outside.

Item #	L"	W"
310211	15 3/4	11 3/4
310212	23 3/4	15 3/4
310213	20 3/4	12 3/4



NEW!

ALUMINIUM SHEET
Without edge.

Item #	L"	W"	Th"
310615	23 3/5	15 3/4	2mm / 3/32



BLUE STEEL OVEN BAKING SHEET

For breads or pastries. Heavy duty. Specially designed for ovens, with 4 gripped edges. Superior quality, deburred. Very distortion resistant. 1/16" thickness.

Item #	L"	W"	Rim	Wt
310101	15 3/4	12	5/8	3 lbs. 1 oz.
310103	23 3/4	15 3/4	5/8	6 1/8 lbs.
310104	25	17 3/4	5/8	7 lbs. 7 oz.



BLUE STEEL OVEN BAKING SHEET WITH STRAIGHT EDGES

Item #	L"	W"	Thk
455001	23 3/4	15 3/4	1/16
455003	20 7/8	12 3/4	1/16



"DENTS DE LOUP" STAINLESS STEEL BAKING SHEET

"Wolves Teeth" stainless steel triangular baking sheet.

Item #	L"	W"	H"
310712	11	11 3/4	1

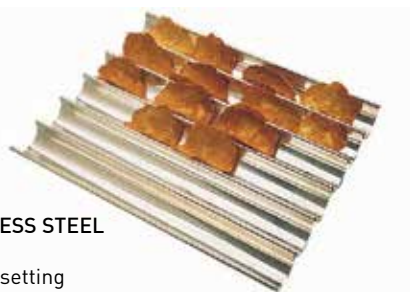

"TUILES" STAINLESS STEEL BAKING SHEET

For easy uniform setting of biscuits. 6 Channel 1 2/3" wide.

Item #	L"	W"	H"
310713	13 3/4	11 3/4	1



NEW!

PERFORATED OVEN SHEET

Perforations Ø 3 mm (1/8"), 4 gripped edges.

Item #	L"	W"	Th"	Wt. lbs
310156	23 3/4	15 3/4	1/16	4

NEW!

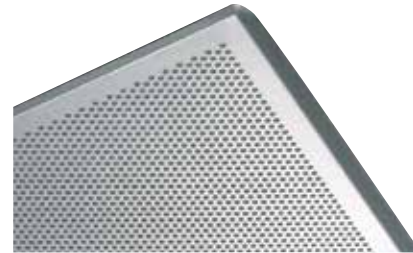

PERFORATED ALUMINIUM SHEET

The perforations contribute to the circulation of hot air, an ideal baking medium for Exopat mats and Flexipan sheets. Perforations Ø 3 mm (1/8"). Gripped edges.

Item #	L"	W"	Th"	Wt. lbs
310612	23 3/4	15 3/4	3/32	2



BLACK STEEL ROUND OVEN SHEET

Ideal for baking pizzas. Made of heavy duty black steel to bake individual cakes and crusts. Thickness 1/16".

Item #	Ø"	Wt
310404	10 1/4	1 lb. 7 oz.
310407	12 5/8	2 lbs. 2 oz.
310408	14 1/4	2 lbs. 7 oz.
310409	15 3/4	3 lbs. 6 oz.



EASY TO CLEAN SINGLE PIECE AND COMFORTABLE GRIP WITH ROUNDED TOPS



EXOGLASS® PASTRY CUTTERS

COMPOSITE MATERIAL DEVELOPED BY MATFER. Its cutting edge is as durable as any long life cutters. This material is non-porous, dishwasher safe and can be sterilized.

- Heat resistant up to 482° F.
- Non-deformable & long lasting.
- Non-stick.
- Dishwasher safe.



EXOGLASS® SQUARE CUTTER

Item #	L"	W"
150241	1 1/2	1 1/2
150244	2 1/8	2 1/8
150247	2 3/4	2 3/4



EXOGLASS® ROUND PLAIN PASTRY CUTTER

Item #	Ø"	Ø mm	Wt oz.
150151	1 1/8	30	1
150152	1 3/8	35	1
150153	1 1/2	40	1
150154	1 3/4	45	1
150155	2	50	1
150157	2 3/8	60	1
150159	2 3/4	70	1
150161	3 1/8	80	1
150163	3 1/2	90	1
150165	4	100	1



LEARN MORE ABOUT THIS PRODUCT IN OUR CHEF LIFESTYLE BLOG.

SET OF EXOGLASS® PASTRY CUTTERS

Item #	Ø"	Wt oz.	Box of
PLAIN			
150103	1 1/8, 1 1/2, 2, 2 3/8, 2 3/4, 3 1/8, 3 1/2, 4	8	8
150104	1 3/8, 1 3/4, 2 1/5, 2 1/2, 3, 3 3/8, 3 3/4	8	7
FLUTED			
150101	3/4, 1 1/8, 1 1/2, 2, 2 3/8, 2 3/4, 3 1/8, 3 1/2, 4	8	9
150102	1 3/8, 1 3/4, 2 1/8, 2 1/2, 3, 3 3/8, 3 3/4	8	7



EXOGLASS® ROUND FLUTED PASTRY CUTTER

Item #	Ø"	Ø mm	Wt oz.	Item #	Ø"	Ø mm	Wt oz.
150110	3/4	20	1	150119	2 3/4	70	1
150111	1 3/16	30	1	150121	3 1/8	80	1
150112	1 3/8	35	1	150123	3 1/2	90	1
150113	1 1/2	40	1	150125	4	100	1
150114	1 3/4	45	1	150126	4 3/8	110	1
150115	2	50	1	150127	4 3/4	120	1
150117	2 3/8	60	1				



ROUND FLUTED PASTRY CUTTER
Made of stainless steel.

Item #	Ø "	Wt oz.
150230	5	6
150231	5 1/2	6
150232	6	6



GREAT WITH OBLONG FLUTED MOLD! SEE P. 37



OVAL FLUTED CUTTER
Made of stainless steel.
Heavy duty, sharp and beveled.

Item #	L "	Wt oz.
150220	6 1/4	4



LATTICE DOUGH CUTTER
New ergonomic handle in plastic, after rolling out, spread dough to obtain diamond shape in the desired width.

Item #	L "	Wt oz.
141110	4	5

ROLLER DOCKER
Perforates pastry dough to eliminate air pockets for even expansion. Food graded.

Item #	L "	Wt oz.
141120	4 3/8	4



- Cuts a crisscross pattern.
- New ergonomic handle.
- After rolling the dough out, spread to obtain a perfectly uniform lattice.



LATTICE PIE CUTTER
Made of stainless steel with polypropylene handle.

Item #	L "	Wt oz.
141105	5	10



PLAIN SQUARE CUTTERS
Made of stainless steel. Heavy duty, sharp and beveled.
Set of 8.

Item #	Ø "	Wt
150320	1 1/2, 2, 2 3/8, 2 3/4, 3 1/8, 3 1/2, 4, 4 3/8	1 lb. 3 oz.



PIC VITE ROLLER DOCKER
Made of polycarbonate. Quickly perforates dough to eliminate air pockets. Food graded.

Item #	L "	Wt oz.
141115	5	8



MINI CROISSANT CUTTER

Made of stainless steel, plastic handles. Cuts triangles of 2 1/3" by 2 3/4" to be rolled into croissants.

Item #	L"
141004	14 1/6



CROISSANT CUTTER

Made of stainless steel, plastic handles. Cuts triangles of 3 7/8" by 8 1/4" to be rolled into croissants.

Item #	L"	Wt
141002	13 3/4	1 lb. 4 oz.



BIKE DOUGH CUTTER

Roller designed to cut pasta for tortellini, farfalle, ravioli. Fitted with 9 removable fluted rollers, spaced 8/13" apart, usable in threes or sixes for strips 1 1/5" to 1 3/4" wide.

Item #
073227



DOUGH CUTTING WHEEL

Made of stainless steel, plastic handle. Serrated.

Item #	L"	Ø"
141029	7 1/4	2 1/3



- This appliance can simultaneously cut several uniform strips 1/2" to 4 3/4" wide.

ADJUSTABLE DOUGH CUTTER

Stainless steel, with several cutting rollers. 2 1/4" Ø.

Item #	# of wheels	# of stripes	Wheels
141013	5	4	Fluted
141010	5	4	Plain



- Stainless steel.
- Min 1/3" gap between blades.
- Variations of gaps between blades can be obtained by the distribution of plastic discs on main roller shaft.



38 BLADE ROLLER FOR STRIP CUTTER

Item #	Ø"	Overall L"
141006	3 7/8	26

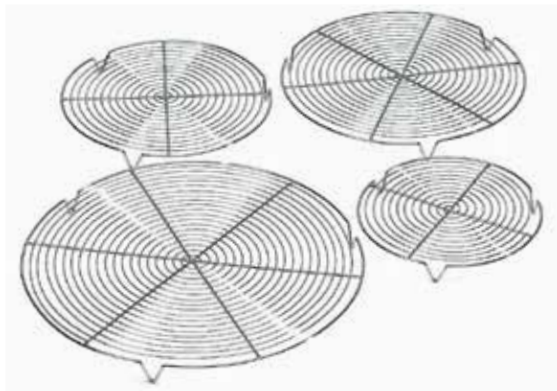

COOLING RACK
Round cooling rack with feet.

Item #	Ø"
312501	7 3/4
312502	9 1/2
312503	11
312504	12 1/2
312505	14

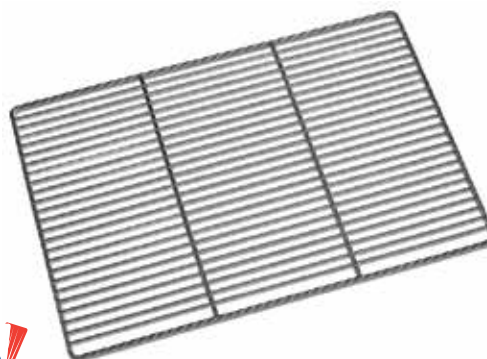

HEAVY DUTY FREEZER GRID
Stainless steel reinforced grid. Specially designed for storing heavy products in freezers.

Item #	L"	W"	H"
312126	23 3/4	15 3/4	2/3



STAINLESS STEEL WIRE GRID WITH FEET
Perfect for cooling product directly from the oven while protecting counter top surfaces.

Item #	L"	W"	H"
312212	23 2/3	15 3/4	1/4

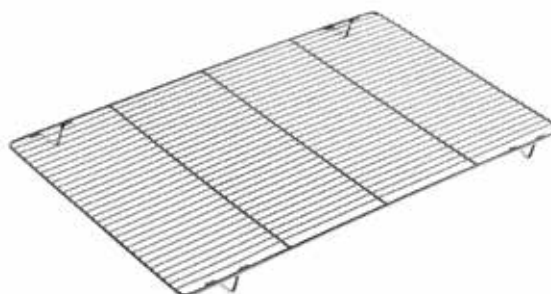



ADJUSTABLE ROLLING PIN

Includes eleven wheels to adjust thickness. Dough thickness from 1/16" to 3/8".

Item #	L"	Wt	Handles
140030	20 1/2	4 lbs. 2 oz.	No



NYLON ROLLING PIN

Very sturdy and rigid. Washable. Made of a single piece.

Item #	L"	Ø"	Wt	Handles
140010	19 5/8	1 3/4	2 lbs. 1 oz.	No



POLYETHYLENE ROLLING PIN

Plain model. Made of a single piece. Washable.

Item #	L"	Ø"	Handles
140018	19 5/8	1 3/4	No



BEECHWOOD ROLLING PIN

Specially designed for culinary schools. Very sturdy for extensive use. For all doughs.

Item #	L"	Ø"	Handles
140005	19 5/8	1 7/8	No



BEECHWOOD ROLLING PIN

Equipped with handles on ball bearings. Very sturdy for extensive use. Stainless steel mounting. Beechwood handles.

Item #	Roller L"	Overall L"	Ø"	Wt lbs.
140126	15 3/4	26 3/4	3 1/8	3



ROLLING PIN WITH NON-STICK COATING

Made of stainless steel with oval handle.

Item #	L"	Wt
N3721	18 3/4	4 lbs. 6 oz.



ALUMINUM ROLLING PIN

Item #	L"	Ø"	Wt	Handles
140028	15	3 1/2	4 lbs. 7 oz.	Yes



- Extra flexible Impermeable with adjustable tip.
- Washable in boiling water.

IMPER MATFER PASTRY BAGS

Made of nylon with soldered seams. Pack of 10.

Item #	L"	Wt oz.	Item #	L"	Wt oz.
161002	9 7/8	1	161006	17 3/4	1
161003	11 3/4	1	161007	19 5/8	1
161004	13 3/4	1	161008	23 5/8	1
161005	15 3/4	1			



- Smooth interior for easy filling.
- Easy to wash and sterilizeable.
- Durable bags for continuous use.

IMPERFLEX PASTRY BAGS

Strong and supple polyurethane pockets without additional soldered joints for improved comforts. Pack of 10.

Item #	L"	Item #	L"
161204	13 1/2	161207	19 3/4
161205	15 3/4	161208	23 1/2
161206	17 3/4		



PASTRY BAG DRYER

Rack made of plasticized wire. Equipped with supports to store bags, tubes and other small items.

Item #	L"	Ø"	Wt
169002	19 5/8	19 5/8	4 lbs. 9 oz.



PASTRY BAG HOLDER

Base can store 8 tips. Very convenient for holding the pastry bag and filling without soiling the tube. Made of polypropylene.

Item #	H"	Ø"	Wt oz.
169001	9 1/4	7 2/3	5



PASTRY BAG CLIPS

Convenient clip for air tight closing of pastry filled bags, or for bags ready to be used. Made of polypropylene. Comes in three assorted colors. Set of 3.

Item #	L"
169003	5 1/2

SUPERIOR QUALITY PASTRY BAGS WITH LARGE SIZE FOR LESS FREQUENT FILLING



HEAVY DUTY DISPOSABLE HIGH HEAT PASTRY BAGS "COMFORT" XL

Item #	L"	W"	Wt lbs.	Roll of
165010	23 1/4	11	1/2	10
165007	23 1/4	11	2 1/2	100

- Heat resistant up to 212° F.
- Smooth inside layer for easy opening and filling of the product.
- Velvet touch outside layer for a firm grip even with wet or oily hands.
- Very sturdy 3 layer film.
- Green pastry bags, sterile and perfectly hygienic.



STANDARD DISPOSABLE PASTRY BAGS

Roll of 100. Rubberized exterior for easy handling. Interior of the bag is slick for easy dispensing. Recyclable and durable but also disposable. Comes in its own box for easy dispensing.

Item #	L"
165015	12
165015MC	Pastry bags (100 roll) - Master Case (6 rolls)
165015P	Pastry bags (100 roll) - Pallet (360 rolls)

Item #	L"	Wt
165018	21	2 lbs. 5 oz.
165018-Master case	Pastry bags (100 roll) - Master Case (6 rolls)	
165018-Pallet	Pastry bags (100 roll) - Pallet (360 rolls)	

Item #	L"	Wt
165019	18	2 lbs.
165019-Master case	Pastry bags (100 roll) - Master Case (6 rolls)	
165019P	Pastry bags (100 roll) - Pallet (360 rolls)	



DISPOSABLE PASTRY BAG DISPENSER

Holds and protects 100-bag rolls. Includes screws for wall mounting. Maximum width 300mm (11 7/8"). Stainless steel + ABS.

Item #	L"	Depth	H"
165030	14 1/6	5 1/3	4 1/2



FOR THE FINEST WRITING ON CAKES AN MORE!



- Ready to use writing bags, no folding necessary.
- The fine tip guarantees writing in a uniform thickness.
- Diameter 0.5 mm (2/100").

WRITING PASTRY BAGS WITH TIPS

Item #	L"	W"	
421805	8 1/2	4 1/2	Pack of 50
421806	8 1/2	4 1/2	Pack of 10



DISPOSABLE POLYETHYLENE PASTRY BAGS

Pastry bags with three layers of polyethylene provide greater strength. Roll of 200.

Item #	L"	Wt
165003	21 5/8	5 lbs. 5 oz.
165003-Master case	Pastry bags (200 roll) - Master Case (8 rolls)	
165003-Pallet	Pastry bags (200 roll) - Pallet (288 rolls)	



TRANSPARENT - HYGIENIC - UNBREAKABLE - NON-DEFORMABLE & LONG LASTING

DECORATING TIPS – POLYCARBONATE

Can be used with both nylon pastry bags as well as disposable pastry bags due to their large support roll.



- Transparent material: easy to spot bubbles.
- Designed to meet requirements of hygiene.
- Unbreakable.
- Do not lose their shape.



SET OF 12 DECORATING TIPS - POLYCARBONATE
6 plain (U3, U5, U7, U9, U11, U13) and 6 scalloped tips (C6, C7, D8, E7, F7, F8).

Item #	Wt oz.
166004	8

SET OF 24 DECORATING TIPS - POLYCARBONATE
12 plain (numbers U1-U12), 10 scalloped (A6, A8, B6, B8, C6, C8, D6, D8, E6, E8). 1 #2 leaf and 1 tube for yule logs.

Item #	Wt oz.
166003	13



SET OF 6 PLAIN TIPS - POLYCARBONATE
6 different openings: U4, U5, U6, U8, U10 and U12.

Item #	Wt oz.
166006	2



SET OF 6 SCALLOPED TIPS - POLYCARBONATE
6 different openings: C8, D8, E8, F8, C6 and D6.

Item #	Wt oz.
166007	2



PASTRY TIPS BRUSH

Specially adapted shape for cleaning any conical - shaped tube, with nylon bristles and plastic handle

Item #	L "	Ø handle "
710214	6 2/3	3/4



SEE P. 241 FOR ALL SHAPE RESULTS.



© Rina Nurra/Ferrandi Pâtisserie

SAINT-HONORE PASTRY TIPS

For decorating the Saint-Honorés, replaces the spoon, serrated, polycarbonate. Pack of 2. TUBE: STH.

Item #	Tube	Ø "
167141		13/32
167142	STH	18/32



© Rina Nurra/Ferrandi Pâtisserie

BIRD NEST PASTRY TIPS

Or vermicelli type, flat tip. Pierced with 7 holes of 1/16"Ø. Polycarbonate. Pack of 2.

Item #	Ø "	Holes
167170	18/32	7



YULE LOG PASTRY TIPS

Polycarbonate, one flat side, one serrated side. Pack of 2.

Item #	W "	Holes
167151	5/8	6
167152	7/8	8



VERINE TUBE

Inserted into a piping bag this long tube enables you to fill verine simply without touching the sides.

Item #	Ø "	H "
167180	1/3	4



SET OF 10 INTERCHANGEABLE PASTRY TIPS

Polycarbonate pastry tips with 2 couplers – can be adapted to any pastry bags – allows you to change the tip without emptying the bag. Box of 10 tips: 3 fluted (E8, D8 and C6), 3 plain (U6, U4 and U2), 1 leg tip BU8, 1 nest tip, 1 petit four tip PF10 and 1 leaf tip no.2 as well as 2 impermeable couplers with adjustable tips.

- Designed to meet hygiene standards.
- Unbreakable and do not lose their shape.
- Transparent material makes it easy to spot bubbles.
- Can be used with both nylon pastry bags as well as disposable pastry bags.

Item #	Wt oz.
166010	7



INTERCHANGEABLE PASTRY TIPS

For use with a base (167300). Enables a change of decorating tube, and therefore decoration, when pastry bag is already filled. Compatible with Duo Decorating Tube (168001) and automatic funnel 116601.

Item #	Description	Item #	Description
167300	2 Bases	167345	2 star shaped tips. D8.
167302	2 plain pastry tips. U2.	167355	2 star shaped tips. E8.
167303	2 plain pastry tips. U3.	167370	2 nest tips.
167304	2 plain pastry tips. U4.	167380	2 petit fours tips. PF10.
167306	2 plain pastry tips. U6.	167430	2 flat leaf tips. FE2.
167333	2 star shaped tips. C6.	167452	2 yule log tips. BU8.

LEAF PASTRY TIPS

Tube no. FE2. Pack of 2.

Item #
167130





SEE P. 241 FOR ALL SHAPE RESULTS.



© Rina Nurra/Ferrandi Pâtisserie



PLAIN TIPS - POLYCARBONATE

Weight 1oz. Pack of 2.

Item #	Ø "	Tube	Item #	Ø "	Tube
167101	2/32	U1	167109	15/32	U9
167103	3/16	U3	167110	1/2	U10
167104	6/32	U4	167111	18/32	U11
167105	7/32	U5	167112	19/32	U12
167106	3/8	U6	167113	21/32	U13
167107	13/32	U7	167114	3/4	U14
167108	14/32	U8	167115	25/32	U15

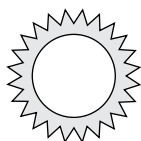

SULTANE PASTRY TIPS

For decorating iced puff. Polycarbonate.

Item #	PROTRUDING CONE				
Item #	FLAT CONE				
Ø ext. base	Ø int. base	Ø est. hole 1	Ø central hole	H "	
166160					
166161					
17/8	1 1/2	1 3/8	7/8	1 5/8	



VERMICELLI TUBE NOZZLES

Pipes 4 lines of 1/12" width in one stroke. New design for decorating small cakes (Mont Blanc Style) and desserts with frostings such as chestnut cream, butter creams and royal icing, etc. Pack of 2.

Item #	Ø "	Tube	Wt oz.
167171			



© Rina Nurra/Ferrandi Pâtisserie



STAR TIPS - POLYCARBONATE

To pipe out star shaped icing or whipped cream. Wt 1oz. Pack of 2.

Item #	Ø "	# Th	Tube	Item #	Ø "	# Th	Tube
167012	2/32	5	A5	167043	7/32	6	D6
167014	1/8	7	A7	167044	9/32	7	D7
167015	1/8	8	A8	167045	5/16	8	D8
167023	3/16	6	B6	167051	1/4	4	E4
167024	1/8	7	B7	167053	9/32	6	E6
167025	5/32	8	B8	167054	5/16	7	E7
167033	6/32	6	C6	167055	11/32	8	E8
167034	1/4	7	C7	167062	3/8	5	F5
167035	9/32	8	C8	167064	1/2	7	F7
167042	5/16	5	D5	167065	17/32	8	F8



PETIT FOUR TIPS - POLYCARBONATE

For a very fine and precise decoration. Weight 1oz. Pack of 2.

Item #	Ø "	# Th	Tube	Item #	Ø "	# Th	Tube
167080	3/8	10	PF10	167086	5/8	16	PF16
167082	1/2	12	PF12	167088	3/4	18	PF18
167084	9/16	14	PF14				



STRAIGHT ROSE TIPS POLYCARBONATE

To create roses and rose petals. Pack of 2.

Item #	Ø "	Tube	Wt oz.
167140	1/2	RD6	1



SINGLE PIECE WITHOUT ROLLED EDGE MEETS ALL HYGIENE REQUIREMENTS



© Rina Nurra/Ferrandi Pâtisserie

SET OF 12 STAINLESS STEEL PASTRY TIPS

Item #	Ø"	Wt oz.	
166500	From 1/6 to 8/13	4	PLAIN SHAPES



Item #	Wt oz.	Assorted star shapes
166700	3	A8, B6, B8, C6, C8, D6, D8, E6, E8, F6, F7 and F8

PASTRY FILLING TUBES

Special tubes with small tips for filling choux pastries, éclairs, religieuses, salambos etc. Suitable for all types of pastry bags. Stainless Steel. Pack of 3.



Item #	Nozzle Ø"
167532	1/12, 1/4 and 4/13



- This wall rack is designed for storing pastry tips made of polycarbonate or stainless steel.
- Each pastry tip can be dried correctly.
- Easy to store.
- The tips are within reach and a model can be selected immediately.
- Rack protects the tips from dirt.
- Holds 24 tips.
- Transparent polycarbonate door.
- Stainless steel base.
- Can be spray-washed.
- Wall attachment with wall plugs and screws included.

RACK FOR PASTRY TIPS

Item #	W"	H"	D"
167900	9 7/8	13	3 1/3

A REVOLUTIONARY INVENTION ! MAKES ORIGINAL TWO-COLOR DECORATIONS

DUO

PASTRY APPLICATIONS: Macaroons, butter cream, custard, Chantilly cream, mousse, meringue, marshmallow, floating island etc.

COOKING APPLICATIONS: Mayonnaise, compound butter, pommes duchesse, mashed potatoes, fine stuffing, etc.



Item #	Wt
168001	2 lbs. 4 oz.



KIT INCLUDES:

- 4 Tubes: 3 grooves of 1/32" and 5/64" opening.
- 4 grooves of 1/32" and 5/64" openings.
- 6 Screw on decorating tubes: plain, star, yule log, tube, etc.
- 1 Pastry Tube Cleaning Brush.
- 1 Recipe Book.



Set of 2 nozzles.

- 1.5 mm/1/13" thickness (RU 1: for icing éclairs, small cakes).
- 5.5 mm/3/13" thickness (RU 5: for individual entremets).

RIBBON NOZZLES

New nozzles created by Matfer for decoration and icing éclairs to appeal to your customers.

Item #	
167175	RU1 1 + RU5



INFRARED MEASUREMENT OF FOOD SURFACE WITHOUT CONTACT



- Perfect for controlling goods at delivery, refrigerated display counters, and cold storage rooms.

INFRARED THERMOMETER

Accuracy: +/- 3°C or +/- 5.4 °F.

Operates with 9 volt battery; recommended for distances between 6 1/3" and 25 1/5". Delivered with case.

Item #	Grad.	Wt oz.
250552	-20 to +260°C or -4 to +500°F	7



- Simple, easy to use
- Mini format

INFRARED THERMOMETER

Accuracy ± 3°C. Resolution: 0.1°. Includes 2 AAA batteries; Measures the temperature of hot, dangerous, messy products: chocolate, sauces, etc.

Item #	Grad.	Wt oz.
250555	-50 to +260°C or -58 to +500°F	2 1/3



WATERTIGHT ELECTRONIC DIGITAL THERMOMETER WITH ALARM

Large display window. 4 7/8" long stainless steel sensor, diameter 4mm/5/32" with protective sheath. Cable length 39 1/2". Accuracy ± 1°C. (1.8 °F). Precision: 0.1 °C. Alarm feature, min/max temp pre-sets. Last temp rec memory. °C/°F measurement. Requires 1.5V battery (supplied).

Item #	Grad.	L "	W "
072271	-50 to +200°C or -58 to +392°F	4 1/3	2 1/2



250528



250538



250536

ELECTRONIC THERMOCOUPLE THERMOMETER

K type thermocouple. IP65 waterproof case. Accuracy ± 0.8°C. (1.44 °F). Resolution 0.1°C / 1°C above 200°C. (0.18 °F / 1.8 °F above 392°F). Conversion between °C and °F. Flat CR 2032 / 3V batteries included. Comes in a blister pack.

Can be fitted with a sensor from the selection below.

SENSOR NOT INCLUDED. USE ITEMS 250536 OR 250538 BELOW.

Item #	Grad.	L "	W "
250528	-67 to +1400°C or -88 to +2552°F	3 1/6	1 2/3

VACUUM PACK THERMOMETER NEEDLE

Fine needle, Teflon coat. Heat-resistant up to 250°C/482 F°.

USE WITH THERMOMETER (ITEM # 250528)

Item #	Cord L "	Needle L "	Ø
250538	39 1/2	2 1/3	1/64" - 1 mm

STANDARD THERMOMETER NEEDLE

Stainless steel needle. Spiral cable:

160 cm/ 63".

USE WITH THERMOMETER (ITEM # 250528)

Item #	L "	Ø "
250536	4 3/4	2/13

WHITE ADHESIVE SEAL

Adhesive foam, certified for food contact, to stick to vacuum bag. When the bag is pierced with this foam, oxygen cannot enter the bag. The hole left by the needle is coated by the foam micro-alveoli which closes once the operation is completed.



Item #	L yards	W "	Thk "
250544	4 1/3	4/9	1/8

PH METER

Watertight model IP65. PH scale 0 to 14.

Measuring margin +/- 1°C or 33.8°F. Resolution:

temperature 0.5°C or 32°F. Resolution 0.1 PH.

Requires 4 x LR44 batteries (included).

Item #
250152





MORE ON P. 125



EXOGLASS® THERMOMETER SPATULA

With built in thermometer which allows you to read the temperature while stirring. Dishwasher safe with thermometer removed.

Item #	L"
113090	15



MORE ON P. 125



ELVÉO THERMOMETER SPATULA

New model with flexible silicone paddle. Designed to mix products while controlling the temperature. Handle resists up to +220°C (428° F) and is dishwasher safe (with thermometer removed).

Item #	L"
113092	15 1/4



WHITE DIGITAL THERMOMETER

Electronic thermometer with digital display. Slim probe tip 2.5mm/3/32" diameter / L 120 mm/4 3/4"" to leave a smaller trace in the product. Precision +/- 1°C (1.8 °F) & result in 5 seconds. Watertight IP67: dishwasher safe. Convertible to °F measurement. Supplied with protective cover for the probe.

Item #	Grad.	L"
250513	°C - 50 to + 200° or F° - 58 to 392°	7 7/8



POCKET DIGITAL THERMOMETER

Electronic, digital display, watertight. 75 mm/3" stainless steel fixed needle. Weight 31 g. Delivered with needle protection case. In blister.

Item #	Grad.	L"	Wt oz.
250502	°C- 40 to + 200° or F° - 40 to 392 °	5 1/5	1



SALOMETER

Made of glass. Graduation from 1000 to 1250 g/e Indicates salt level of your stock, soup or other liquid (grams per ml).

Item #	L"	Wt oz.	Mercury free
250105	7 7/8	1	Mercury free



SYRUP DENSITY METER

Graduation from 1000 to 1400 g/e.

Item #	L"	Wt oz.	Mercury free
250108	5 1/4	8	Mercury free



FREEZER THERMOMETER

Alcohol based. Made of plastic. Easy to read. Mercury free.

Item #	Grad.	L"	Wt oz.
250301	- 4°F to 122°F	7 3/4	9



CHOCOLATE THERMOMETER

Made of polycarbonate. Marks from 0 to 60°C. Mercury free.

Item #	Grad.	L"	Wt oz.
250305	complete with polycarbonate protector	6 3/4	1



OUR THERMOMETERS USE A SPECIAL LIQUID: GUARANTEED MERCURY-FREE

CANDY THERMOMETER

- Perfectly legible, glass body
- Red alcohol

Item #	1	Grad.	L "
250330	Mercury free, polyamid protector	80°C to 200°C	11 7/16

SPARE PART
Replacement candy thermometer (mercury free).

Item #	2	Ø "	L "	Wt oz.
250332		3/4	11 3/4	15



MERCURY FREE CANDY THERMOMETER
Mercury free. Stainless steel protector.

Item #	Grad.	L "
250331	80°C to 200°C	77 3/4

CANDY THERMOMETER HOLDER
Made of stainless steel. Allows you to have an immediate read of the temperature anytime during the cooking process. Hooks on any kind of pan and sugar pan to fit many thermometer sizes.

Item #	L "	Wt oz.
250500	5-3/8	3



- Digital display and magnetized back with clip.
- Supplied in a blister pack.
- 3 functions:
Sec countdown timer / Stopwatch / 24hr clock

24 HOUR 3 FUNCTION DIGITAL TIMER

Item #	L "	W "
250602	2	2 7/8

SYRUP DENSITY METER TEST TUBE
Made of stainless steel 18/10.

Item #	Ø "	H "	Wt oz.
250112	1 3/8	6 7/8	9



- Digital display.
- Magnetized back with clip.
- Easily fits in a pocket.
- Supplied in a blister pack.

20 HOUR DIGITAL TIMER MAGNET BACK & CLIP

Item #	Ø "	W "
250601	2	2 7/8



DOUGH CUTTER

Made of stainless steel with polyamide handle.

Item #		L"	W"	Wt oz.
112900	rigid blade straight cut	4 3/8	4 1/2	4
112901	rigid blade rounded cut	4 3/8	4 1/2	4
112902	flexible blade straight cut	4 3/8	4 1/2	4
112903	flexible blade rounded cut	4 3/8	4 1/2	4



EXOGLASS® RIGID DOUGH CUTTER

Made of an innovative composite material: non-deformable, non-stick, long lasting, dishwasher safe.

Item #		L"	W"	Wt oz.
112825	straight	4 1/2	3 1/8	2
112826	rounded	4 1/2	3 1/8	2



EXOGLASS® ELVEA SCRAPER

Made of an innovative composite material: non-deformable, non-stick, long lasting, dishwasher safe.

Item #	L"	W"	Wt oz.
112845	4 3/4	2 3/4	3

- Very resistant.
- Polyamide structure : exceptional robustness and durability.



LEARN MORE ABOUT THIS PRODUCT IN OUR CHEF LIFESTYLE BLOG.



MATFER SCRAPER

Multipurpose, scrapes just about everything.

Item #	L"	W"	Wt oz.
112840	4 3/4	3 3/4	1



DOUGH SLICER

Made of seamless stainless steel, with beveled edge. Rigid blade.

Item #	L"	W"	Wt oz.
112822	5 1/4	4 3/4	6



PASTRY, CAKE, DESSERT FLOAT

White ABS. Ideal for working with fondant icing.

Item #	L"	W"
421717	7	3 1/3



STAINLESS STEEL SIEVE

Stainless steel body. Heavy duty stainless steel mesh. Suitable for sifting. Mesh 1.28 mm.

Item #	Ø"
115082	8 2/3
115084	11 7/8



SET OF 3 SIEVES METAL MESH

Stainless steel mesh sieve.

Item #	Ø"	H"
115020	7, 8, 10	12/3



WOODEN SIEVE

Stainless steel mesh # 18. Mesh 1.3 mm.

Item #	Ø"
115012	7 1/2



AUTOMATIC FLOUR SIEVE

Made of stainless steel.

Item #	Ø"	H"	Wt oz.
115060	4 1/3	3 1/2	6



TONG - PASTRY CRIMPER

Made of stainless steel.

To decorate the edge of the tart crust.

Item #	L"	Wt oz.
112501	4	1



- Bakery: Flexible, yet highly robust, this is a smoothing tool for spreading products on baking trays or a worktop and scraper for all types of bowls.
- Kitchen: General purpose, designed especially for scraping the bowls of professional pans or cookers.
- Thick all-silicone scraper.
- Dishwasher proof.

SILICONE SCRAPER

Item #	L"	W"	H"
114006	7 1/8	4	3/8

DECORATING COMB

- For decorating biscuits.
- White plastic support, thick and very solid, comb in flexible plastic.
- Reversible with different patterns on each side.
- Available in 2 lengths 13 7/16" and 27 1/8" (for sheet work).



1 THIN STRIPED COMB



Item #	L"
421705	27 1/8
421735	13 7/16

2 SPECIAL STRIPED COMB



Item #	L"
421706	27 1/8
421736	13 7/16



3 SIDED DECORATING COMB

Made of plastic. Triangle with different sized jagged teeth on each edge. To create a pattern on icing.

Item #	L"	Wt oz.
421702	3 5/8	1



3 SIDED DECORATING COMB

Made of stainless steel. 3 different teeth patterns.

Item #	L"
421704	4 1/8



CHARLOTTE COMB

Not recommended for dishwasher. 2 sided comb with teeth 5/13" high, rounded on side and straight on the other.

Item #	L"	W"	Wt
421709	27 3/8	4 5/8	1 lb. 9oz.



PASTRY COMB

For a wood grain look.

Item #	L"
421700	8



AN ABSOLUTE ESSENTIAL FOR A SMOOTHER SPREAD



MATFER SILICONE PASTRY BRUSH

Pastry brush was specially designed by Matfer: This shape and arrangement make it easier to hold the product for a smoother spread.

- Wide head has more than 130 offset conical bristles.
- The head is heat-resistant up to 482°F.
- The silicone head is molded over the composite handle, ensuring the handle will not come off.
- Easy to clean and dishwasher safe.

Item #	L"	W"
113042	8 2/3	1 1/2



© Rina Nurra-Ferrandi Pâtisserie

- The collar and handle are sealed and can not be disassembled.
- Handle and collar in composite material.
- Dishwasher safe.

LEARN MORE ABOUT THIS PRODUCT IN OUR CHEF LIFESTYLE BLOG.



MATFER POLYAMIDE FIBER BRUSH
Bristles in synthetic fiber, food grade.
Handle and collar in composite material.

Item #	Bristle L"	W"	Wt oz.
116002	2	1 1/8	1
116004	2	1 5/8	1
116006	2	2	2
116008	2	2 3/8	2
116009	2	2 3/4	2



PASTRY BRUSH

Natural bristles, not chemically treated, food grade.

To limit the loss of bristles always soak the brush for 1 hour in clear water before using for the first time.

FLAT

Item #	Bristle L"	W"	Wt oz.
116011	1/3	1	1
116012	1/3	1 1/8	1
116013	1/3	1 3/8	1
116014	1/3	1 1/2	1
116015	1/3	1 3/4	2
116016	1/3	2	2
116017	1/3	2 3/8	2
116018	1/3	2 3/4	3

ROUND

Item #	Bristle L"	Ø"	Wt oz.
116020	2	1/2	2

IDEAL FOR DECORATING CAKES



In plastic, with special non-skid coating, with non-skid feet.



TILTING AND REVOLVING CAKE STAND

Item #	Ø"	H"	Base Ø
421503	11 7/8	5 5/8	9 5/8

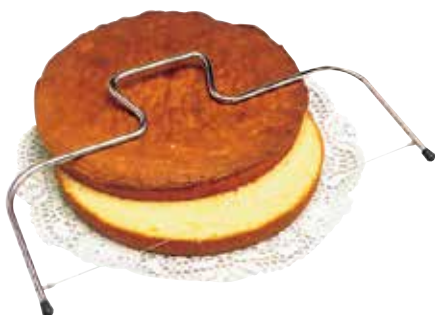

CAKE SLICER

For symmetrically cutting cake perfectly for decorating. Frame in chrome steel. 5 adjustable slicing heights: 20, 30, 40, 50 and 60 mm (10/13", 1 1/5", 1 3/5", 2" and 2 1/3").

Item #	L"
120090	17 1/3
120092	Pack of 10 spare wires



CAKE MARKER

Made of lightweight and durable plastic. Designed with 2 handles for easy use. Make perfectly sized slices on round cakes. Ideal for bakeries.

Item #	# of portions	Ø"	Wt oz.
154051	14	10 1/2	4
154052	reversible for 12 & 18	10 3/4	6
112657	16	10 1/4	4



REVOLVING CAKE STAND "STABILODECOR"

Aluminum, mounted on a pivot in a heavy cast iron stand for decorating entremets and assembled pieces.

Item #	Ø"	H"
421501	12	5



BAKING BEANS

Food Contact. For "BLIND" baking of bases of all shapes. Impeccable results for uniform and perfect bake.

Item #	
340001	Aluminum 2 lbs.
340002	Ceramic 2 lbs.



- Easy to read and use.
- Hardwearing.

BRIXOMETER BY GÉRARD TAURIN

5 years Gurantee; Measurement range from 0% to 90%; Supplied in a wooden case.

Item #	Ø "	L "	Wt oz.
250128	1 37/64	5 29/32	6.35



REFRACTOMETER

High definition. For checking sugar content expressed in % Brix. Reader Ø 40 mm (1 1/2"). Reference temperature 20°C (68°F), sample temperature 40°C (104°F) maximum. Comes in a protective box.

- 1: Refractometer 0 to 50 %. Precision ± 1 % for sorbets, ice creams, fruit juice concentrates etc.
- 2: Refractometer 58 to 90 %. Precision ± 0,5 % for jelly, jam, syrups.

Item #	L "	Wt oz.
1. 250122	5 7/8	5
2. 250124	5 7/8	5



BLOW TORCH

Adjustable flame, electronic ignition, refillable like a lighter. Butane not included.

Item #	W "	L "	Wt
262263	4 1/4	5 3/4	1/2 lb.



- Very easy to use.
- Digital readout in less than 3 seconds.
- Double Brix/Baumé scale.

PAL-PÂTISSIER REFRACTOMETER

To precisely monitor sugar content in sorbet, ice cream, jam, jelly. Meas.: 0 to 85% Brix, 0 to 45° Baumé. Precision: ± 0.2% Brix, ± 1° Baumé. Meas. Temp.: 10°C or 10°F to 40°C or 104°F.

Item #	L "	W "	H "
250130	4 19/64	1 7/32	2 11/64



1. SUGAR PUMP

Made of rubber and copper. The best pump available for all your blown sugar. Delivered with one copper tip. The air bladder delivers a large volume of air quickly. The wide easy grip hose assures secure handling.

Item #	L "	W "	H "	Wt oz.
262230	14	2 3/8	2	1



2. SUGAR PUMP "ECONOMY"

Made of rubber and copper.

Item #	L "	Copper tip "	Wt oz.
262235	10	5 1/8 long	4



SUGAR SCISSORS

In finely polished stainless steel with black laquered handles.

Item #	L "	Wt oz.
072200	9 1/4	8



SUGAR WORK GLOVES

Made of latex.

Item #	Size
262289	S
262290	M
262291	L

DESIGNED FOR DECORATING WITH THE AIRBRUSH AND FOR APPLICATION OF ICING



AIRBRUSH FOLDABLE CABINET (SPRAY BOX)



- Polypropylene, fully foldable and washable.
- Its size is such that the sheet 23 3/4" x 15 3/4" can be used to work on.
- Int. dim. int. : 24 3/8" x 16 1/3" x 15 1/2".
Sylvie AMAR DESIGN registered model.

Item #	L"	W"	H"
410120	25 1/5	20 1/4	16 1/6



- Main Users: Fast food, Bakery.
- It is lighter and quieter with reduced overspray compared to more powerful guns.
- Important-it is not suitable for thicker liquids such as glaze or egg wash!!

OIL SPRAY GUN

Designed for spraying thinner materials such as oil and water, it can deliver a volume of as low as 80g/min. Comes with an R4 nozzle, a bent nozzle extension, 2 x 550 ml containers with 1 lid and has a 30 Watt power rating. Viscosity: 18-36 DIN/sec. Delivery Rate*: 80-140g/min.

Item #
264911



- Main Users: Pastry Chefs, Artisans.
- Ideal for finishing, velvet/frozen effects, molds, speckling pralines, cakes etc.

CHOCOLATE SPRAY GUN

This innovative heated chocolate sprayer has been designed specifically to spray a warm mixture of 50% chocolate & 50% cocoa butter at 28-35C: Heating & insulation avoids nozzle clog. It also includes an R6 round nozzle, a bent nozzle extension and a 550ml container. For pure cocoa butter, buy the optional R4 nozzle. Needing only 40 Watts, it is precise and benefits from minimal overspray. Viscosity*: 20-28 DIN/sec. Delivery Rate: 120-200g/min.

Item #
264912



ESSENTIAL TOOLS FOR PASTRY CHEFS AND FOOD INDUSTRY PROFESSIONALS

ELECTRICAL SPRAY GUNS

Spraying saves time and reduces material wastage by up to 60% compared to brushing.
M45: food safe spraying for medium-high viscosity such as chocolate, marzipan, glaze etc.



- Refrigerator and microwave safe.
- Designed for the kitchen environment.
- Certified as "food safe".
- Handheld & electric-no air compressor needed.
- Simple to use, clean and maintain.



NEW!

FOOD SPRAYER

Features: - Even spraying for jellies, coatings and glazes. Saves times and reduces waste.
 - Manual pressure.
 - Adjustable jet spray.
 - Graduated from 0.25 to 1.25L.
 - Gauged at 1.6 L.
 - PE body, PP-PA head.

Item #	Wt oz
264908	54



AIRMASTER AIR BRUSH AND COMPRESSOR

Pastry airbrush. Comes with 1 air brush and professional compressor. 110V. Adjustable air pressure (0-30 psi). Maintenance free.

Item #	Wt
410105	8 lbs.



- Heavy duty and easy to clean.
- Hygienic Electrical element detachable to enable dishwashing.



ADJUSTABLE POWER for controlled product use

DIFFERENT SPRAY NOZZLE size



ANGLED NOZZLE extension

ERGONOMIC handle

700 ml screw-in cup EASY TO CHANGE

Item #	
264906	ELECTRICAL SPRAY GUN M45



MORE ON THIS PRODUCT ON P. 220

SPARE PARTS

Item #	Ø mm	
264046	0.4	Round jet nozzle R4
264047	0.6	Round jet nozzle R6
264048	0.8	Round jet nozzle R8
264049	0.7	Flat jet nozzle F7S
264051		Angled nozzle extension
264052		Suction feed extension
264053		700 ml bowl with lid
264054		Atomiser insert

CONFECTIONERY FUNNEL WITH STAND

This polycarbonate funnel facilitates refilling and dosage of liquids: alcohols, jellies, coulis, sauces, creams, etc.

PRECISE DOSING
with thumb-action handle

ERGONOMIC handle

TRANSPARENT
BODY
enables better
visibility

WATERTIGHT JOINT



FLASH TO LEARN MORE ABOUT THIS PRODUCT
IN OUR CHEF LIFESTYLE BLOG.



- Light and easy to handle.
- Precision guaranteed in all circumstances.
- Uniquely comfortable to use.
- Supplied with chrome-plated wire stand.
- Dishwasher safe.



CONFECTIONERY FUNNEL WITH STAND
Supplied with 4 nozzles
Ø 1/13", 1/6", 3/13" and 4/13" and stand.

Item #	Ø"	Capacity
116540	8 1/4	1 1/2 qt



CONFECTIONERY FUNNEL WITH STAND
Mechanism can be dismantled for easy cleaning. Supplied with stand. Comes with one nozzle Ø 1/6". Can use Mafter nozzles #167300 to 167452.

Item #	Ø"	L"	Capacity
116601	5 1/2	10 2/3	3/4 qt

THE PASTRY CHEF'S PAINTBRUSH



- Opening nozzle measurement is 1/3".
- Delivered with two additional nozzles of 1/8" and 1/4".

STAINLESS STEEL CONFECTIONERY FUNNEL

Item #	Ø"	L"	Wt	Capacity
258825	7 1/4	7 1/8	2 lbs. 2 oz.	2 qts

STAND FOR FUNNEL

Item #	Ø"	L"	Wt oz.	
116515	5 1/2	8 7/16	15	item 258825

DECOSPOON



Set of 2 stainless steel spoons. With a simple gesture you can bring a touch of savory color to your dishes.

- The large decospoon is for sauces and elegant garnishes : ideal for spots and bold lines.
- The small decospoon is ideal for text, spirals and majestic curves.

Item #	L"
116436	9 & 7 1/2



DECOSPOON INKWELL

This SAN pot is designed so that the sauce stays at the bottom facilitating the loading of the decospoon. The silicone element allows you to clean the decospoon properly.

Item #	Ø"	H"
116437	2 1/6	3



- The precise portion control in the kitchen or in the pastry shop contributes to better control over food cost and will bring consistency in production.
- A single pressure on the handle will deliver a precise portion.
- Depending on the viscosity of the product, the portion is easily calibrated up to 2/3 of a fl. oz. (20 cc, capacity of the piston chamber).
- The graduated positions on the screw allow setting the portion for chosen recipe, producing the same portion over and over.
- Made of poly carbonate and has a capacity of 1-1/2 qt.
- Resists temperatures up to 250 degrees.
- The funnel is easily taken apart without tools, for cleaning.
- Dishwasher safe. Includes chromed stand.
- Perfect visibility when filling.
- Screw fixing 1/8" diameter.

Item #	H"	Ø"	W with handle"	Wt
116605	16 1/2	8 5/8	10	4 lbs. 1 oz.

SPARE PARTS

Item #	Wt oz.
116530	White tube screw holder 1



PORTION CONTROL FUNNEL

Designed to deliver precise portion control of different product consistencies like: mayonnaise, ketchup, mustard, jellies and fruit paste, syrup and liquors, cream and coulis.





CHEF MEG GALUS
CHICAGO - USA

CHOCOLATE



RAPID MANUFACTURE OF PLAIN OR SCREEN-PRINTED DISCS & CHOCOLATE TUILES



- Unit made entirely of stainless steel.
- Completely dishwasher safe.
- Dimensions: 25" x 6 1/2" x 3 1/4".



KITS FOR MAKING CHOCOLATE TUILES & DISCS

Kit consists of a perforated plate and a chocolate container/shuttle. To be used on a "guitar" pvc sheet or transfer sheet.

HOW TO USE

1. Place the plate Width -wise on the 1st third of a "guitar" PVC sheet.
2. Position the shuttle at one end of the plate and fill with chocolate.
3. Slide the shuttle to the other end of the plate - as it moves, chocolate fills the perforations.
4. Lift the base and place it on the 2nd third of the sheet.
5. Do the same thing twice more to cover the entire 23 3/4" x 15 3/4" sheet.

Chef's Tip: Place the kit in oven at 86°F/95°F before use to avoid the chocolate solidifying too quickly in contact with the stainless steel.

Item #		Ø"	H"
385040	Palets	1 1/2	2
385050	Tuiles	2	3





INJECTED POLYCARBONATE CHOCOLATE MOLDS WITH MANY ADVANTAGES



- 
- Smooth for shine.
 - Easy product removal.
 - Easy to clean and maintain.
 - High durability.
 - Transparent for easy coloring & decoration.

BUTTERFLY DECORATIONS MOLD
Polycarbonate sheet produces 18 pieces.

Item #	L"	W"	Wt oz.
380178	2 1/5	7/8	12



STYLISH FLOWER DECORATIONS MOLD
Polycarbonate sheet produces 15 pieces.

Item #	L"	W"	Wt oz.
380183	1 7/8	1 1/2	12



HEART MOLD
Produces 18 pieces. 11 g (1/5 oz.)

Item #	L"	W"	H"
383410	1 1/6	1 1/6	2/3

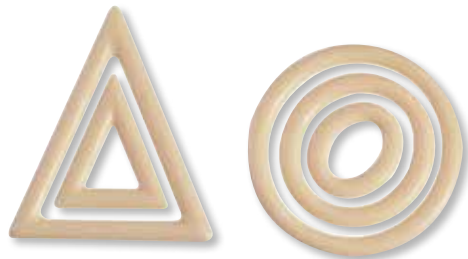

GEOMETRIC MOLD

Item #	Shape	Dimensions"
380184	2 triangles	2 2/3 x 3 1/6 & 1 1/2 x 1 7/8
380185	3 circles	Ø 2 3/4, 2 & 1 1/6



OVAL SHELLS MOLD

Sheet produces 24 molds 1/3 oz. each.

Item #	L"	W"	H"
383502	1 1/3	1	1/2



HEARTS IN RELIEFMOLD

Sheet produces 24 molds 1/3 oz. each.

Item #	L"	W"	H"
383607	1 1/6	1 1/10	3/4



ROUND SHELLS MOLD

Sheet produces 24 molds 1/3 oz. each.

Item #	Ø"	H"
383303	1 1/10	1/2



SQUARE SHELLS MOLD

Sheet produces 24 molds 1/3 oz. each.

Item #	L"	W"	H"
383205	1 1/16	1 1/16	1/2



CHOCOLATE BAR MOLD

4 x 7 squares pattern.

Item #	L"	W"	H"
380258	8 1/6	3 1/2	3/8



HALF SPHERE MOLD

Produces 3 pieces.

Item #	Ø"
380125	2



MINI BOWLS MOLD

15 molds.

Item #	L"	W"
380257	1 5/8	2/3



HALF SPHERE MOLD

Produces 3 pieces.

Item #	Ø"
382051	4 3/4



HALF SPHERE WITH GROOVES MOLD

Item #		Ø"	H"
383600	2 grooves	21 pieces	1 1/2
383601	8 grooves	6 pieces	1 1/2



15 MINI BARS MOLD

Sheet produces 15 mini bars 7/8 oz. each.

Item #	L"	W"	H"
380147	3	7/8	2/3



PYRAMID MOLD
Produces 30 pieces.

Item #	L"	W"	H"
380265	1	1	1

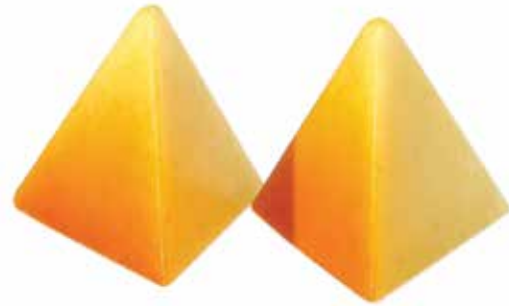

PYRAMID MOLD
21 molds. 5,5 g (1/8 oz.). Mold size 10 7/8" x 5 1/3".

Item #	L"	W"	H"
380123	1 1/8	1 1/8	1 1/8



QUENELLE MOLD
Double sided. 2 x 8 molds 2 x 10 g (1/3 oz.).
Mold size 10 7/8" x 5 1/3".

Item #	L"	W"	H"
380167	1 3/4	1	1/2



WOODEN SQUARE MOLD
32 molds. 11,5 g (1/5 oz.). Mold size 10 7/8" x 5 1/3".

Item #	L"	W"	H"
380122	7/8	7/8	3/4



HIRAI MOLD
21 molds 7 g (1/4 oz.). Mold size 10 7/8" x 5 1/3".

Item #	Ø"	H"
380712	1 1/8	3/4



MINI CHRISTMAS TREES
28 molds 5 different designs. 9 g (1/3 oz.).
Mold size 10 7/8" x 6 7/8".

Item #	L"	W"	H"
380169	1 1/4	7/8	7/8



HOLLY LEAVES MOLD
14 molds. 5 g (1/8 oz.). Mold size 10 7/8" x 5 1/3".

Item #	L"	W"	H"
380209	2 1/4	1 1/3	1/3



SMALL CANNELE MOLD
40 molds. 9 gr (1/3 oz.). Mold size 10 7/8" x 6 7/8".

Item #	Ø"	H"
380108	1	1





STICKS DECORATIONS MOLD

Polycarbonate sheet produces 22 pieces.

Item #	L"	W"	Wt oz.
380186	4 1/3	1/4	12



7 ESPRESSO CUPS MOLD

Item #	Ø"	H"	Wt oz.
380255	2 1/16	1 5/12	12



COMMA BULLION MOLD

Polycarbonate sheet produces 24 pieces.

Item #	L"	W"	H"	Wt oz.
383408	4 1/3	1/4	1/2	12



3 CUP SAUCERS MOLD

Can be combined with 380255.

Item #	Ø"	Wt oz.
380254	3 1/6	12



HEARTS MOLD

Polycarbonate sheet produces 36 small hearts.

Item #	L"	W"	H"	Wt oz.
380205	1 3/16	1	1/32	10



COFFEE BEANS MOLD

Small grains 104/sheet.

Item #	L"	W"	H"	Wt oz.
380211	9/13	6/13	1/6	12



RECTANGULAR SWEETS MOLD

Polycarbonate sheet produces 24 pieces.

Item #	L"	W"	H"	Wt oz.
380111	1 1/3	7/8	3/4	12



RABBIT MOLD

Two Polycarbonate mold halves to obtain 1 textured rabbit.

Item #	L"	W"	Wt oz.
382012	5	3 1/2	12



SQUARE DOME MOLD
Produces 24 pieces.

Item #	L"	W"	H"
380187	1	1	2/3



TRUFFLES MOLD
Produces 24 pieces.

Item #	Ø"	H"
380190	1	7/8



ARABESQUE MOLD
Produces 24 pieces.

Item #	L"	W"	H"
383007	1 3/8	3/4	1/2



SQUARE SHELLS MOLD
Produces 24 pieces.

Item #	L"	W"	H"
383202	1 1/6	1 1/6	1 1/6





DIAMANT MOLD
Produces 18 pieces.

Item #	L"	W"	H"
383008	2	3/4	1/2



WAVES MOLD
Produces 21 pieces.

Item #	L"	W"	H"
380188	2	1	5/8



8 MINI BAR CHOCOLATE SHEET

Item #	L"
380134	4 3/5



LOGS MOLD
Produces 16 pieces.

Item #	L"	W"	H"
383006	2	3/4	1/2



HALFSPHERES MOLD
Produces 24 molds.

Item #	Ø"	H"
380242	1 1/4	2/3



ROSES & CUP MOLD

Item #	Ø"	H"	Wt oz.	Shape	Cavity
380152	1 1/8	5/8	12	Rose	32
380141	1 1/4	1 1/4	12	Cup	24



1.

2.

ASSORTMENT MOLD

Sizes vary by shape.

Item # 1	Wt oz.
380104	36 pieces; round, oval & lozenge 12

Item # 2	Wt oz.
380105	24 pieces; shells, eggs, snails, hearts, etc 12



CHOCOLATE TABLETS MOLD

Polycarbonate sheet produces 3 tablets of 18 squares each.

Item #	L"	W"	H"	Wt oz.
380240	6	2 3/4	1/3	12



DIAMOND MOLD

Polycarbonate sheet produces 21 pieces.

Item #	L"	W"	H"	Wt oz.
380102	1 1/4	1	3/4	12



"LEGO" PIECES MOLD

Polycarbonate sheet produces 24 pieces.

Item #	L"	W"	H"	Wt oz.
383407	1 1/8	1 1/8	1/2	12



WICKERWORK SQUARE MOLD

Polycarbonate sheet produces 24 pieces.

Item #	L"	W"	H"	Wt oz.
380112	1	1	2/3	12



TULIP RECTANGLES MOLD

Polycarbonate sheet produces 36 pieces.

Item #	L"	W"	H"	Wt oz.
380107	1 1/8	7/8	3/4	12



CHESS PIECES MOLD

Polycarbonate sheet produces 16 games pieces.

Item #	Wt oz.
380222	sizes vary by shape 12





ADD DECORATION TO SMOOTH EGGS AND MAKE THEM UNIQUE



GLOSSY EGG MOLD

Four Polycarbonate molds to create two glossy eggs.

Item #	L"	W"	Wt oz.
382031	5	3 1/2	12



OVAL SWEETS MOLD

Polycarbonate sheet produces 28 pieces.

Item #	L"	W"	H"	Wt oz.	Shape
380161	1 1/4	3/4	1/2	12	Striped
380158	1 1/8	3/4	1/2	12	Rib



SHELLS MOLD

Polycarbonate sheet of 24 mold halves to produce 12 solid shells.

Item #	L"	W"	Wt oz.
380221	1 1/3	1 1/3	12



STRIPED HALF CIRCLES MOLD

Polycarbonate sheet produces 28 molds.

Item #	Ø"	H"	Wt oz.
380163	1 2/3	1/2	12



HALF SPHERES MOLD

Polycarbonate sheet.

Item #	Ø"	H"	Wt oz.	
380249	32 molds	1	1/2	12
380148	15 large molds	1 1/2	3/4	12
380153	12 molds	2	1	12
380154	6 molds	2 3/4	1 1/3	6

STRIPED MOLD

Polycarbonate sheet produces 28 pieces.

Item #	L"	W"	H"	Wt oz.	Shape
380165	1 1/3	3/4	1/2	12	Triangle
Item #	Ø"	H"	Wt oz.	Shape	
380164	1 1/4	3/4	12	Circle	



FOR FAST HIGH-VOLUME PRODUCTION CUTTING OF CHOCOLATE, CARAMEL, CANAPES, FRUIT JELLIES, ETC.

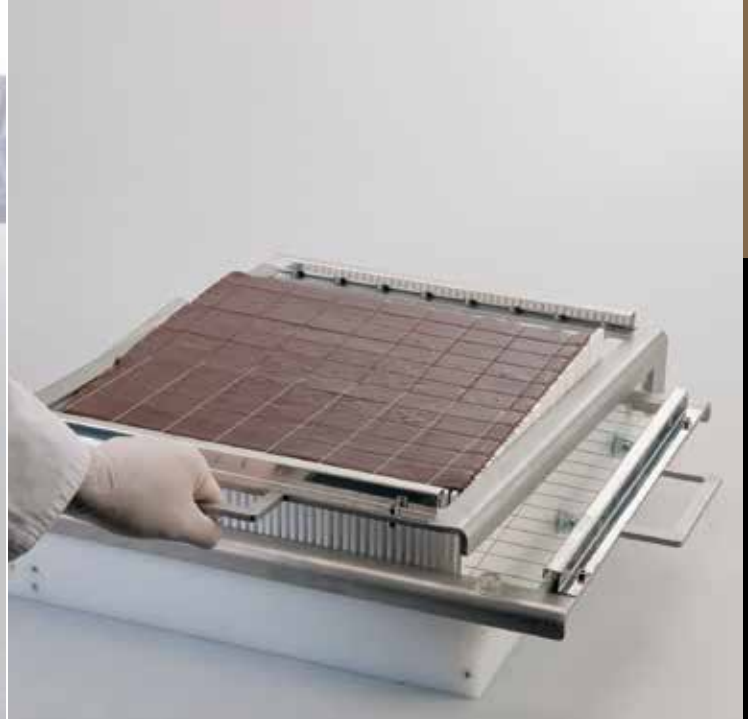

DOUBLE GUITAR CANDY SLICER

The double guitar avoids having to turn product when slicing, saving time and provides improved cutting precision. Device must be used with two cutting frames. Cutting arms interchangeable with necessary tools.



- Cuts into five different rectangular shapes.
- Cutting arms available in four different sizes.
- Dishwasher safe base.
- Stainless steel plate, wire key and 3 spare wires included.



- Working plate in stainless steel fitting two foldable side tables.
- Structured with two pivot wheels with brakes and adjustable cylinder wheels insuring good stability.
- Includes four racks for storing, cutting frames, sheets or grids and slide out drawer.

Item #	
263540	Base only
263542	Cutting Arm 1/2" only
263543	Cutting Arm 7/8" only
263544	Cutting Arm 1 1/5" only
263545	Cutting Arm 1 3/4" only
263512	Spare Wire 27 1/2" only
	Dimensions of the base:
	20" x 20" x 6 1/2" high
	Overall dimensions:
	24" x 24" x 6 1/2" high



TROLLEY FOR GUITAR SLICER

Table specially designed for slicing with guitar machine.

Item #	Working plate "	Folding side tables"	Total surface"
263500	21 1/4 x 26 3/4	13 3/4 x 30 3/4	48 7/8 x 30 3/4

ENSURING A CLEAN CUT WITHOUT HAVING TO MOVE THE PRODUCT DURING CUTTING



SUPPLIED WITH:

- 2 cutting arms of 22 mm.
- 1 stainless steel tray.
- 1 spatula and wire tensioning keys.
- 15 and 30 mm cutting arms of the mini model can be fitted to this model.

MINI DOUBLE-ARM GUITAR

Item #	
263550	



- Easily interchangeable stainless steel cutting arms.
- Polyethylene and ABS base.
- Supplied with one cutting arm 3/4" spaces.
- 1 stainless steel turning plate and clamp key for wires.
- Optional cutting arms of 1/2" and 1 1/8" spacing available.

MINI GUITAR CANDY SLICER

Perfect for small production needs in restaurants, training colleges, pastry shops.

Used to cut strips, squares or rectangles of ganache, fruit jellies, cream desserts, etc.

Item #	
263530	Base with cutting arm
263535	Optional Cutting Arm
263537	Optional Cutting Arm
263512	Cutting Wire
	Dimensions of the base":
	9 1/2" x 10"
	Overall dimensions:
	17 1/2" x 13 1/8" x 5 1/2" high

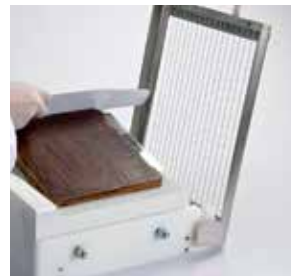

1 | Place.

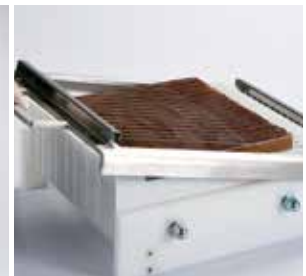

2 | Cut.

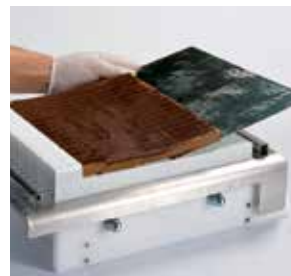

3 | Retrieve.

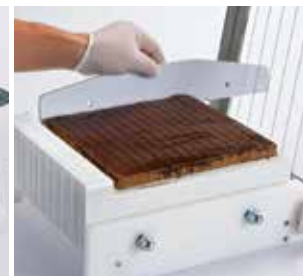

4 | Turn and adjust.



5 | Cut.

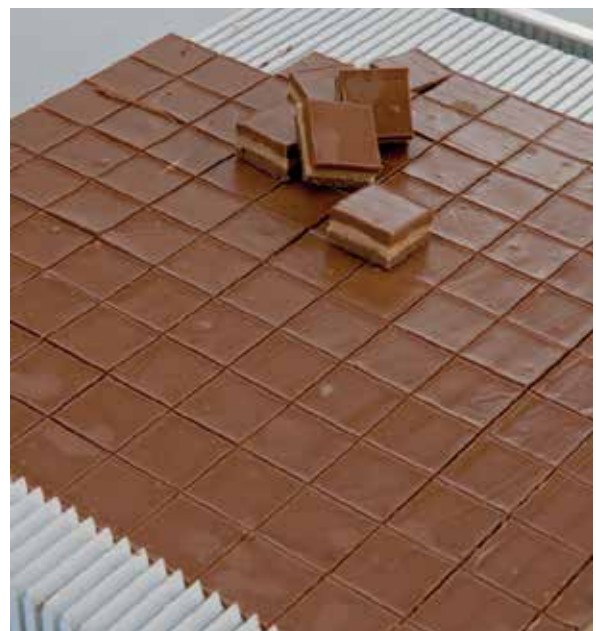



ERGONOMIC HANDLE FOR IDEAL HANDLING

NEW!

SET OF 8 CHOCOLATE FORKS

For marking the tops of chocolate bonbons after coating. 8 assorted decoration models: 1 tine, 2 tines, 3 tines, round, square, triangular, droplet-shaped, zig-zag. Operational angle can be adapted to the maker's own hand – just fold. Hexagonal handle for ideal handling. Comes in a storage case.

Item #	Wt oz.
262010	15



Set includes:

- 4 round forks dia. 9/16", 5/8", 3/4", 13/16,
- 1 oval fork,
- 1 pear shaped fork,
- 1 spiral shaped fork,
- 3 forks: 2,3 and 4 tines.



SET OF 10 CHOCOLATE FORKS

Made of stainless steel, polypropylene handle. For dipping of chocolate candies.

Item #	Wt oz.
262001	15



CHOCOLATE FORKS

Rigid stainless steel wire spit, polypropylene handle 3 7/12".

Item #	Shape	Ø"
262012	ROUND SPIT	6/16
262013	ROUND SPIT	8/16
262014	ROUND SPIT	9/16
262015	ROUND SPIT	10/16
262016	ROUND SPIT	11/16
262017	ROUND SPIT	3/4
262019	PEAR-SHAPED SPIT	
262020	SPIRAL SPIT	
262021	2-TINE FORK	
262022	3-TINE FORK	
262023	4-TINE FORK	
262024	5-TINE FORK	



SET OF 5 CHOCOLATE FORKS

With case. Set includes.

Item #	Wt oz.
262002	9





TRIANGLE SPATULA

Very rigid blade, bevelled cutting edge. Ideal model for scraping oven sheets. Stainless steel, plastic handle.

Item #	L"
112722	9 3/4



COATING SPATULA

For chocolate. Blade in stainless steel. Black polypropylene handle.

Item #	L" blade	W" blade
112641	7	4



MARZIPAN SCULPTING SET

Made of plastic. For decorating Marzipan to cut flowers, ridges, dimples, etc. Shapes include: fine bone, blade and shell, marbles, comb, cone, needle, insert knife and cones 5 and 6 stars. Box of 8.

Item #	L"	Wt oz.
431220	6	4

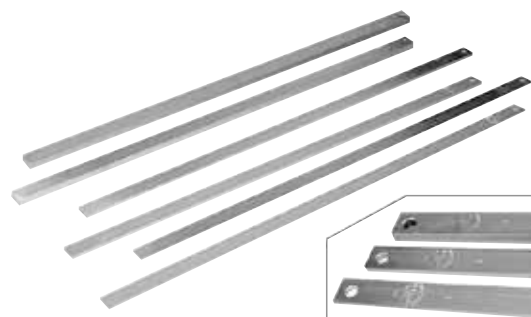

- 2 rulers of thickness 2/16".
- 2 rulers thickness 3/16".
- 2 rulers thickness 6/16".

CONFECTIONERY RULER SET - HEAVY DUTY

Made of aluminum, ideal for fondant, caramel and sugar work. Set of six 11/16" wide rulers in highly polished aluminum for spreading fondant, ganache, caramel, etc., in slabs of uniform thickness. These are marked and perforated. Set contains.

Item #	L"	Wt lb.
140204	23 3/4	1

NEW!



CHOCOLATE TRANSFERT STAMP

Stainless steel stamp with handle to flatten transfers or dipping paper on individual chocolates.

Item #	L"	W"
262030	2 1/3	1 1/4



MARZIPAN SCULPTING TOOLS

Each sculpting tool consists of 2 tools, one at each end in composite material. Box 12.

Item #	L"	Wt oz.
421832	5 1/8	3



FRUIT JELLY FLEXIBLE MOLDS

Each mold consists of 24 cavities with a rigid base.
Sheet size: 7" x 13".



- Easy and simple to use.
- Food grade silicone.
- Product releases with ease.



HALF STRAWBERRY MOLD

Item #	Ø"	H"
339011	1 7/16	13/16



TANGERINE SLICE MOLD

Item #	Ø"	H"
339010	1 3/4	9/16



HEART MOLD

Item #	Ø"	H"
339016	1 3/16	7/16



RASPBERRY MOLD

Item #	Ø"	H"
339013	1 3/16	15/16



PALET ROUND MOLD

Item #	Ø"	H"
339017	1 5/16	11/16





LEARN MORE ABOUT THIS PRODUCT
IN OUR CHEF LIFESTYLE BLOG.



SHEET FOR CHOCOLATE WORK X 100

Superior quality, ensures excellent chocolate shine.
Pack of 100.

Item #	L"	W"
261908	23 5/8	15 3/4



- **Chocolate:** Width adapted to the scraping of the chocolate bars at the coater exit.
- Its ergonomics and its weight also facilitate regular smoothing of the cover for decorating on guitar sheets or a Cool Decor plate.
- **Confectionery:** The Matfer scraper is ideal for working the nougatines, hard boiled sweets or other confectionery products.
- **Bakery:** Flexible, yet highly robust, this is a smoothing tool for spreading products on baking trays or a worktop and scraper for all types of bowls.
- **Kitchen:** General purpose, designed especially for scraping the bowls of professional pans or cookers.
- Thick all-silicone scraper.
- Dishwasher proof.



SILICONE SCRAPER

Item #	L"	W"	H"
114006	7 1/8	4	3/8



COLD PLATE FOR EASY-TO-SHAPE CHOCOLATE DECORATIONS



- The stainless steel plate contains a eutectic liquid that freezes at -21°C (-6°F).
- Tempered chocolate is applied with a cone, a pastry bag, a triangle or a spatula on the plate.
- Chocolate undergoes heat shock when in contact with the cold frozen plate.
- When the chocolate is detached, it can be shaped.

To create home-made meshes, nests, chips, twisted chocolate ribbons, very original to wrap around or decorate desserts & chocolates. You can even mix the colors when applying them on the plate.



COLD PLATE

Special shape to fit slides in chilling cabinets. Stainless steel with non-slip feet. Tip: You can also use the Cold Plate as a cold support for chilled desserts.

Item #	L"	W"	Wt
423060	23 3/4	15 3/4	20 1/3 lbs.



CHOCOLATE SCRAPER

Designed with 3 different sides for: grating chocolate on the Cold Plate, comb chocolate to make stripes in cookies. 1 smooth side. 1 side with small grooves. 1 side with large grooves. White ABS, semi-flexible.

Item #	L"	W"
421743	7 1/2	4 1/2

POLYURETHANE CHOCOLATE APRON

Polyurethane apron with adjustable neck strap and elastic hook on the back. Excellent fat resistance, easy to clean with water and degreaser.



Item #	L"	W"
774002	45	35



HOURS

Lunch: 12h - 13h

Monday to Friday: 7h30 - 19h30

Saturday: 9h - 19h30

Dinner: 19h - 23h

Tel: +33 (0)1 71 93 0 1 4

hours: hours@karamel.paris.com

www.karamelparis.co

Follow us



CHEF NICOLAS HAELEWYN
PARIS - FRANCE

KITCHEN TOOLS





EXOGLASS®: INNOVATIVE COMPOSITE MATERIAL DEVELOPED BY MATFER



EXOGLASS® UTENSILS

Will meet your high standards for sanitary hygiene in food contact environments:
Non-porous, easy to clean and can be sterilized.

- Long-lasting - Non-deformable.
- Will not deteriorate or rust over time.
- Perfect for non-stick coated pans will not scratch.
- Heat Resistant: up to 430° F.
- Dishwasher Safe.



EXOGLASS® PELTON SPATULA

One-piece composite material with flexible blade.
Perfect for non-stick coated pans: will not scratch.

Item #	L"	Wt oz.	Top W	Color
NEW! 112419	12	2	3 1/2	●
112420	12	2	3 1/2	●
112421	12	2	3 1/2	●
112422	12	2	3 1/2	●
112424	12	2	3 1/2	●



EXOGLASS® SPOON

One-piece composite material.

Item #	L"	Wt	Color
113330	12	3 oz.	●
113331	12	3 oz.	●
113332	12	3 oz.	●
113334	12	3 oz.	●
113338	15	3 oz.	●
113345	17 3/4	3 oz.	●



EXOGLASS® DUOLON TONGS

Designed for non-stick frying pans to easily turn foods.

Item #	L"	Wt oz.
112425	11 1/2	1



EXOGLASS® PLAIN PELTON SPATULA

Flexible blade. Dishwasher safe.

Item #	Color	L"	W"	Wt oz.
NEW! 112429	black	12	3 1/2	1
112430	gray	12	3 1/2	1



ELVEO HIGH TEMPERATURE RUBBER SPATULA FOR JARS
Spatula with narrow paddle, very practical for easy scraping and emptying of jam, mustard, sauce jars and pacojet or frix'air jars. Dishwasher safe.

Item #	L"	Wt oz.
113720	10	4



SILVEO SPATULA SCRAPER
Designed to effectively scrape all kinds of containers, smooth chocolates without scratching them, line ice cream molds, and smooth entremets. Effortlessly scrapes the bottom of containers with flexible silicone blade and the wide, robust, and ergonomic Exoglass® handle. Heat resistant paddle up to 500°F, handle up to 428°F."

Item #	L"	W"	Wt oz.
114005	8 1/2	4 3/4	3



EXOGLASS® KITCHEN SPATULA

Item #	L"	Wt oz.
113025	9 7/8	2
113030	11 7/8	3
113035	13 3/4	4
113040	15 3/4	5
113045	17 3/4	6
113050	19 3/4	8

- Exoglass® composite handle.
- Blade made of thermoplastic elastomer, resistant to temperatures up to 500° F.
- Features a square angle for easy scraping sides of containers.
- Recommended for containers with non-stick coating.



ELVEO HIGH TEMPERATURE RUBBER SPATULA
Flexible blade for easy scraping of sides of pans and containers.

Item #	L"	Wt oz.
113724	10	4
113735	13 3/4	4
113745	17 3/4	5



SPATULON SPATULA
Exoglass® composite material handle, thermoplastic elastomer, slightly hollow blade. Perfect to fill pastry bags. Handle 6 2/3". Paddle 4"x2 3/4".

Item #	L"
113825	9 7/8
113833	13



EXOGLASS® FLAT BEVELLED SPATULA

Item #	L"	Wt oz.
113501	13 3/4	3

© Eric Fenot - Le grand cours de cuisine de l'Ecole Ferrandi





MODERN SHAPE AND COMFORTABLE GRIP DURING USE



LEARN MORE ABOUT THIS PRODUCT IN OUR CHEF LIFESTYLE BLOG.



EXOGLASS® CURVE SERVING UTENSILS

Designed for buffet service. Will meet your high standards for sanitary hygiene in food contact environments.

- Non-porous, easy to clean.
- Can be sterilized.
- Long-lasting - Non-deformable.
- Perfect for non-stick coated pans: will not scratch.
- Heat Resistant: up to 430° F.
- Dishwasher Safe.



CAFETERIA TONGS

Item #	L"	Color
650202	9 7/8	Grey
650194	9 7/8	Lime green



TOPPING TONGS

Item #	L"	Color
650204	6 3/4	Grey
650196	6 3/4	Lime green



PLAIN SERVING SPOON

Item #	L"	Color
650198	11 7/8	Grey
650190	11 7/8	Lime green



PERFORATED SERVING SPOON

Item #	L"	Color
650200	11 7/8	Grey
650192	11 7/8	Lime green



DESIGNED TO MIX PRODUCTS WHILE CONTROLLING THE TEMPERATURE



LEARN MORE ABOUT THIS PRODUCT IN OUR CHEF LIFESTYLE BLOG.



- Handle resists up to +220°C (430° F) and is dishwasher safe (with thermometer removed).
- -20° to +200°C (-4° to 392° F) removable thermometer, 1°C reliability, splash-proof.
- New model with flexible silicone paddle for thorough scraping of the bottom of containers during cooking and retrieving all of the product afterwards.

ELVÉO THERMOMETER SPATULA

Designed to mix products like cream sauces, sugar and chocolate in the pan, bain-marie, or chocolate dipping machine, while controlling the temperature.



Item #	L"
113092	15 1/4



EXOGLASS® SPATULA

With built in thermometer which allows you to read the temperature while stirring. Dishwasher safe with thermometer removed.

Item #	L"
113090	15



EXOGLASS® 8 BLADE PICKLE SLICER



This product is a real time saver for cutting small vegetables such as radishes or pickles for decorative purposes.

- Dishwasher safe EXOGLASS® handle.
- Perfect junction between blades and the handle to improve hygiene.
- 8 Razor sharp stainless steel blades.

Item #	Wt oz.
120903	2



EXOGLASS® ZESTER CURLER
High-performance sharp zester blade. With EXOGLASS® handle. For right or left handers. Dishwasher safe.

Item #	L"
120910	6



5 YEAR WARRANTY

GARLIC AND ONION PRESS
Cast aluminum with highly durable coating. Dishwasher safe. Easy to use.

Item #
072890



SILICONE COOKING BRUSH
Silicone brush for use in the kitchen and roasting spit for brushing sauces, flavored butters or marinades on warm meat or preparations. Heat-resistant up to 572°F (300°C). Dishwasher safe.

Item #	L"
113041	7 1/2



NEW!

GARLIC PRESS/CUTTER
Cuts garlic into 2 mm (3/32") cubes. Stainless steel grille and blade.

Item #	L"	W"	H"
072892	9	2 1/3	2



FRUIT & MUSHROOM SLICER
Made of stainless steel. Equipped with 7 stainless steel blades for uniform cut slices at one time. Dishwasher safe.

Item #	Wt oz.
N4194	2



GARLIC PEELER TUBE
Flexible and solid evoprene. Quick garlic peeling. No hand contact. Insert garlic cloves inside the tube, roll back and forth and the skin comes off.

Item #	L"
072897	1 1/2
	5 1/10

5 YEAR WARRANTY



RADISH DECORATOR
Made of cast aluminum with a dishwasher safe finish. Stainless steel blades.

Item #	Wt oz.
215312	4



5 YEAR WARRANTY



APPLE/PEAR DIVIDER - 10 SLICES

Made of cast aluminum, epoxy treated with stainless steel blades. In one push this tool cores the fruit. Dishwasher safe. Cuts it in 10 uniform parts.

Item #	Wt oz.
072770	6



AVOCADO PEELER / SLICER

Stainless steel. Easy to use. Dishwasher safe.

Item #	Wt oz.
N4196	4



APPLE/PEAR DIVIDER - 16 SLICES

Cores and produces 16 equal slices in one step. Made of ABS. Stainless steel blade.

Item #	L"	W"	H"
072773	6 7/8	5 1/2	2 1/3



MELON DIVIDER - 12 SLICES

The sharp, serrated knives cut the fruit easily and cleanly into 12 sections. Cuts melons up to 19 cm (7 1/2") in diameter. Stainless steel blade, ABS handle.

Item #	Ø"	L"	W"	H"
283245	7 1/2	11 2/3	8 2/3	2 3/4



APPLE/PEAR DIVIDER - 8 SLICES

Stainless steel blades and rubber coated handles. In one push this tool cores the fruit. Dishwasher safe.

Item #	Wt oz.
215315	6



MANGO SPLITTER AND PITTER

Simply press on the mango once to obtain two halves with minimum waste. Non-slip handles and stainless steel blade.

Item #	Wt oz.
215317	4





DOUBLE VEGETABLE BALLER

To core apple, melon, tomato etc., effortlessly. With EXOGLASS® handle. Two different cutting diameters on each end. Stainless steel. Dishwasher safe.

Item #	Ø "	Wt oz.
121009	7/8 & 1	2



TOMATO CORER

Stainless steel body, black plastic handle.

Item #	L "
090417	4 7/8



APPLE CORER

Made of stainless steel, EXOGLASS® handle. Serrated, sharpened blade makes work easy. Dishwasher safe.

Item #	Ø of corer	Wt oz.
120925	7/8	2



SCOOPING SPOON

Special design shape ensures easy scooping of avocado, melons, etc. Stainless Steel. Polypropylene handle. Dishwasher safe.

Item #	L "	Wt oz.
112443	7 1/4	2



GRAPEFRUIT KNIFE

Curved blade, finely serrated on both sides, EXOGLASS® handle. Right or left hand use. Dishwasher safe.

Item #	Wt oz.
120912	2



FRUIT DECORATOR KNIFE

Stainless Steel. For melons, grapefruits, tomatoes, etc. Dishwasher safe. With EXOGLASS® handle.

Item #	W blade "	L blade "	Wt oz.
120916	12/13	3-1/2	2



RADIMAX SPIRAL KNIFE

Small tool used to make spirals by turning the blade around the shaft spiked into a vegetable (black radish, cucumber, carrot, etc). Plated aluminum handle, stainless steel blade and shaft.

Item #	L"
120938	9 1/2



FRUIT AND VEGETABLE CORER

2 cutting sizes for rapid coring of fruits and vegetables to garnish them with another texture. Stainless steel blade, PP handle.

Item #	L"	W"
120932	5 1/8	2 1/2



VEGETABLE TURNING DECOR

To decorate or transform vegetables into small containers for sauces, creams or espumas. Kit includes 2 stainless steel blades and a handle, 2 different diameters and sizes: Ø 1 1/2" (Ø 40mm) and Ø 3/4" (Ø 20mm).

Item #	L"	W"
181009	5 1/8	2 1/2



JULIENNE SPIRAL CURLER

Use like a giant pencil sharpener to create decorative strips of carrot, courgette or cucumber. The red silicone bracket ensures clean contact with blade. Dishwasher safe.

Item #	Ø"
120913	4



JULIENNE CUTTER

For cutting zucchini, carrots, cucumber, turnips, apples and pears... Apply gentle pressure to the julienne cutter and draw it along the length of the vegetable to be cut. Stainless steel and dishwasher safe.

Item #	L"	W"
120907	7	1 3/4

SPARE PART

Item #		
181052	3 blade set	3, 6 & 45 mm



STAINLESS STEEL PINEAPPLE SLICER

Peels, slices and removes core by rotating the handle. Cut pineapple stem, insert corer and rotate. Keep the pineapple shell for decoration.

Item #	Ø"	H"	Wt oz.
072703	3 1/2	9 1/2	10



RAZOR SHARP SWIVEL BLADE FOLLOWS THE SHAPE OF THE VEGETABLE WITH EASE



EXOGLASS® PROFESSIONAL PEELER

Razor-sharp: effortless peeling without jamming.

Item #	Wt oz.
120901	2



- Perfect junction between blade and handle improves hygiene.
- Blade insures cutting without using a paring knife.
- Easy to clean and dishwasher safe.
- Right or left hand usability. EXOGLASS® handle.

TOP BLADE ensures cutting without using paring knife.

SWIVEL BLADE helps to follow the vegetable shape.

DISHWASHER SAFE HANDLE.

RAZOR-SHARP BLADE.

PERFECT JUNCTION between blade and handle improves hygiene.

ELECTROLYTE POLISHING of stainless steel ensures easy cleaning.



VEGETABLE PEELER

Ideal for peeling long vegetables. Dishwasher safe.

Item #	L"	W"
090384	4 1/3	2

TOMATO AND KIWI PEELER

Serrated blade made of stainless steel. Dishwasher safe.

Item #	Wt oz.
120906	2



BUTTER CURLER

Stainless steel blade, polypropylene handle. May also be used to scale fish or scoop out the flesh from zucchinis. Dishwasher safe.

Item #	Wt oz.
120920	2



BUTTER PORTIONER

Frame made of cast aluminum, epoxy coated, stainless steel cutting wire is tightened individually. Slices butter in 3/8" portion. Dishwasher safe.

Item #	Frame dimensions"	Wt oz.
073085	4 3/4 x 3 1/8	8



SANDWICH KNIFE

Stainless steel, polypropylene handle. Serrated on one side for easy cutting of bread, and flexible on the other to ensure easy spreading of mayonnaise. Dishwasher safe.

Item #	L blade"
121021	3 1/3



5 YEAR WARRANTY

HAND HELD CHERRY STONER

Made of cast aluminum with dishwasher safe coating. Removes stones and stems simultaneously.

Item #	Wt oz.
073095	3



5 YEAR WARRANTY

OLIVE STONER

Made of cast aluminum. Spring-loaded device facilitates pitting. Dishwasher safe.

Item #	Wt oz.
215408	8



MANUAL JUICER

Made of cast aluminum. Epoxy coated. Dishwasher safe.

Item #	Wt lb.
072900	1



CITRUS JUICER

Heavy duty 18/10 stainless steel. To extract the flavorful juice of all your citrus fruits. Comes with bowl that fits underneath. Perforated juicer cone.

Item #	Wt oz.
020280	8





STAINLESS STEEL EGG RING
 Ideal for giving your preparations perfect roundness: fried eggs, omelettes, as well as blinis, pancakes, etc. when cooking in a pan, griddle plate, etc. Handle for easy use.

Item #	L"	Ø"	H"
215425	5 1/2	3 1/3	5



EGG KNOCKER / EGG SHELL CUTTER
 Made of stainless steel.

Item #	L"	Ø"	Wt oz.
215307	9 1/2	1 1/2	6



EGG WEDGER 6 SECTIONS
 Stainless steel. Dishwasher safe.

Item #	L"	Ø"
400497	8 1/4	2 1/2



TABLE CRUMBER
 Stainless steel blade plastic grip.

Item #	L"	Wt oz.
061607	5 1/2	5



5 YEAR WARRANTY



- Made of cast aluminum epoxy treated.
- Stainless steel wires.
- 5 year warranty.
- Dishwasher safe.

EGG WEDGER
 Cuts egg in six equal wedges.

Item #	Wt oz.
215304	5



5 YEAR WARRANTY

LEVER TWO-WAY EGG SLICER
 Base made of cast aluminum, epoxy coated. Stainless steel cutting wire is tightened individually. Dishwasher safe.

Item #	Space between wire	Wt oz.
215306	2 1/4	8



EGG TOPPER
 Made of stainless steel.

Item #	Ø"	Wt oz.
661241	2 1/2	2



Food grade plastic and stainless steel, removable, and can be put in the dishwasher. Blister packed.



NEW!



SAUCE SYRINGE

Essential for injecting flavoured jus into roasts, fish, poultry, and shellfish to spice up the taste and keep the meat moist during cooking.

Item #	L"	Size	Wt. oz.
215452	6 1/10	Needle Length 4 3/4	1 1/2



DUCK AND LOBSTER PRESS

Polished brass traditional culinary tool. For carcass juice extraction (pressed duck) convenient for both preparation or presentation in a restaurant dining room.



Item #	Wt lbs.
612205	30



POULTRY NEEDLE

Stainless steel.

Item #	L"
120841	7 3/4
120842	9 3/4



LARDING NEEDLE

Stainless steel.

Item #	L"
120852	9 3/4



A genuine 100% steel kitchen press to extract all remaining juices from cooked carcasses.



STAINLESS STEEL DUCK AND LOBSTER PRESS

Presses poultry, shellfish and the like to extract juices for sauces or mashed preparations.

Item #	Wt lbs.
215545	25





SCALLOP SHELL KNIFE ERGOBLUE
 XL blade 110 mm (4 1/3"). Blue ergonomic handle.

Item #	L"
121050	8 7/8



SMALL FISH SCISSORS
 Scissors with short, pointed blade to open small fish with precision. Serrated blade to prevent slipping.

Item #	L"
121133	7 1/8



OYSTER KNIFE
 Stainless steel blade. Plastic handle. Dishwasher safe.

Item #	L"
090420	6



OYSTER KNIFE WITH GUARD
 Stainless steel blade. Plastic handle. Dishwasher safe.

Item #	L"
121045	5 1/2



OYSTER KNIFE
 Stainless Steel Blade. Wood handle.

Item #	Wt oz.	L" blade (without guard)
121042	1	2 3/8



FISH KNIFE

Item #	L"
182131	7



SHELLING SCISSORS
 Stainless steel. Scissors designed to save time in preparation of shrimps, prawns and scampi, while preserving the flesh in one piece. Curved blades with harpoon.

Item #	L"
120807	6 3/4



SEA URCHIN OPENER
 Made of stainless steel.

Item #	Wt oz.
N4174	5



SEA URCHIN SCISSORS
 Extremely sharp steel chrome blades.

Item #	L"
121135	6



FISH SCALER

Aluminum. Cast in one piece. Effective for scaling both small and large fish.

Item #	L"
121100	8 1/2



FISH SCALER

Stainless Steel. Heavy duty serrated edge, comfortable plastic non-skid plastic handle. Prepare fish faster and easier than ever before.

Item #	blade L"
121103	12 1/4



SCALEX FISH SCALER

Made of cast aluminum epoxy treated. Long special stainless steel blade for fast scaling. Scale collector avoids dispersing scales. Dishwasher safe.

Item #	L"
073135	8 1/4



CHEF TWEEZERS

Stainless steel. Long, thin tips excellent for handling delicate ingredients. Dishwasher safe.

Item #	L"	Wt oz.
PAP4	11 3/4	1

STAINLESS STEEL CHEF TONGS

Stainless steel.

Item #	L"	Wt oz.
652012	5 1/2	1
NEW! 652013	11 3/4	1/2
NEW! 652020	5 7/8	1/4
NEW! 652021	7 7/8	1
NEW! 652022	13 3/4	1 1/2



FISH BONE TONGS FLAT EDGE

Flat-edged tongs for removing large fish bones. Comfortable grip. Built-in spring. Stainless steel. Dishwasher safe.

Item #	L"
121136	6 3/4



FISH TWEEZER

Stainless Steel. Great to remove fish bones without disturbing the flesh. Bevelled bottom.

Item #	L"	Wt oz.
112503	3 5/8	2



FISH SHEARS

Stainless steel blades with 1 serrated blade to avoid slipping on fish skin. Right-handed model.

Item #	L"
121134	6 1/3



STAINLESS STEEL LADLES AND SKIMMERS

Heavy duty one-block 18/10 stainless steel piece.

STAINLESS STEEL LADLES

Item #	Ø"	Vol oz	Wt
112021	2 3/8	1 5/8	5 oz.
112022	3 1/8	4 3/8	7 oz.
112023	4	8 1/2	11 oz.
112024	4 3/4	15 1/4	14 oz.
112025	5 1/2	22 5/8	1 lb. 1oz.
112026	6 3/8	33 3/4	1 lb. 6 oz.
112028	7 7/8	67 3/4	1 lb. 15oz.



- 1 Large hanging hooks.
- 2 Thick curved handles: better grip, very rigid.
- 3 Curved handle base: very solid.
- 4 Skimmers have Ø 1/8" holes throughout the surface for efficiency.
- 5 Ladles have convenient size and vol marks.
- 6 Pour-neutral edge: does not drip.

STAINLESS STEEL SKIMMERS

Item #	Ø"	Handle	Wt
112061	3 1/8	10 5/8	5 oz.
112062	4	12 1/2	7 oz.
112063	4 3/4	13 3/8	9 oz.
112064	5 1/2	16 1/2	11 oz.
112065	6 3/8	16 1/2	15 oz.
112066	7 1/16	16 1/2	1 lb. 3 oz.



STAINLESS STEEL WIRE SKIMMER

Made of welded stainless steel wire. Perfect for frying. Removes all small items with no hassle.

Item #	Ø"	Handle	Wt
112293	5 1/2	14	10 oz.
112295	7	14	12 oz.
112298	9 1/2	14	1 lb. 2oz.



SKIM'ALL

by Matfer

Item #	Ø"	L"
112282	4 3/4	16 1/6

- Ergonomic EXOGLASS® handle: easy to pick up and sturdy, the curved handle makes it easy to retrieve on the worktop.
- Industrial dishwasher safe.

PART FRYING SKIMMER, PART SKIMMER, the SKIM'ALL enables you to carefully retrieve and drain even the smallest poached and fried products.

PRACTICAL
Sturdy and practical hanging loop.

COMFORTABLE
Curved handle is comfortable.

FOR RETRIEVING FINE PRODUCTS
Single-piece mesh, no soldering. fine 3mm. Very soft for use with delicate products.

SOLIDITY
Exoglass® heat-insulated material. Heat resistant up to 430°F.

EFFICIENT
Holds products with a groove around the edge.



LEARN MORE ABOUT THIS PRODUCT IN OUR CHEF LIFESTYLE BLOG.





UNTWISTABLE STAINLESS STEEL WIRES MOLDED IN AN EXOGLASS® HANDLE.

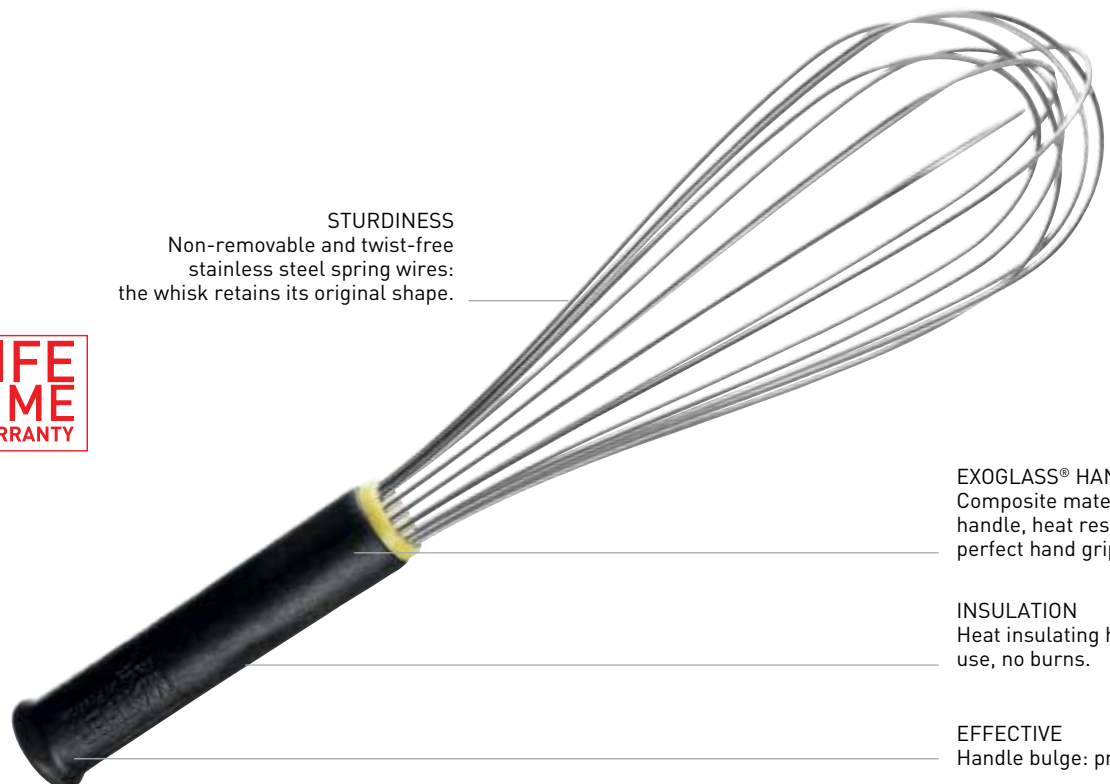

STURDINESS
Non-removable and twist-free stainless steel spring wires: the whisk retains its original shape.



EXOGLASS® HANDLE
Composite material waterproof handle, heat resistant up to 430°F, perfect hand grip.

INSULATION
Heat insulating handle: convenient use, no burns.

EFFECTIVE
Handle bulge: prevents slipping.



PIANO WHISK
Stainless steel. EXOGLASS® handle.

Item #	L"	Wt oz.
111022	10	2
111023	12	5
111024	14	6
111025	16	6
111026	18	9
111027	20	10

EGG WHISK
Balloon shaped.

Item #	L"	Wt oz.
111046	17 3/4	9

RIGID WHISK
Rigid wire like a spring, dia. 1/16", for thick preparations (mashed potatoes, puff dough, pate, etc.).

Item #	L"	Wt oz.
111035	16	9
111036	18	10



LEARN MORE ABOUT THIS PRODUCT IN OUR CHEF LIFESTYLE BLOG.



SPIRAL WHISK

Available in June 2019



Guarantees flawless results for a silky, even sauce with perfect binding

Benefits:

- The perfect shape for getting into nooks and crannies.
- Rotating spiral design to suit all pots and pans, easy mixing.
- Ideal for cooking milk-based sauces and creams (custard, Béchamel, etc.) without them sticking.

Specifications:

- Air- and watertight Exoglass® handle.
- Stainless steel head.
- Spiral can be disassembled.

Item #	L"	Handle
111055	13 3/8	6 2/3

GIANT SKIMMER

Stainless steel. Welded fabric. Shovel dimensions : 11" x 9".

Item #	L"
071230	33 1/2

GIANT KITCHEN WHISK

Made of heavy duty stainless steel. This whisk will ease the mixing of your preparations, reductions, stews etc.

Item #	L"	Wt
111060	40	1 lb. 12 oz.
111061	48	1 lb. 15 oz.

GIANT REDUCTION SPATULA

Stainless steel. This perforated paddle will ease the mixing of your preparations, reductions, stews etc.

Item #	L"	Wt lbs.
112015	39 3/8	3

GIANT EXOGLASS® SPATULA

Handle made of stainless steel. The shape of this spatula has been specially designed to move the products, and scrape the bottoms and corners of kettles, whether round or rectangular.

Item #	L"	Wt
112011	31 1/2	1 lb. 4 oz.
112013	39 3/8	
112012	47 1/4	1 lb. 12 oz.



WALL RACK HOLDER

A smart mounting system to conveniently hold 3 tools. Holds any utensil with round handle (Ø3/4" to 1 1/4"). Utensils are hung and removed very easily with one movement. The rack holder is 2 1/3" from the wall, in order to prevent utensils from touching the wall. Stainless steel, plastic rollers. Delivered with 4 screws and pins.

Item #	L"	W"	Wt
112030	14	2 7/8	1 lb. 7 oz.





UNIQUE FILTRATION QUALITY WITH TRIPLE LAYER, EXTRA FINE MESH.



EXOGLASS® BOUILLON STRAINER

Designed for intensive use: use to make fine stuffings and to strain sauces.



- MADE OF HEAVY DUTY COMPOSITE MATERIAL.
- Resistant up to 430° F.
- Dishwasher safe.

Item #	Ø"	Handle"	Wt lb.
017360	8	7 1/2	1
017362	10	9 1/4	1 1/2



LEARN MORE ABOUT THIS PRODUCT IN OUR CHEF LIFESTYLE BLOG.

2 hooks for STABILITY.



STURDY—KEEPS ITS SHAPE:
Body and handle made of one-piece composite material.

COMFORTABLE insulated handle.

One-piece ERGONOMIC handle.

HYGIENIC stainless steel mesh.

Stainless steel wire REINFORCEMENT.

EXOGLASS® BOUILLON STRAINER - MASTER CASE
12 pieces

Item #	Ø"
017360MC	8
017362MC	10



STAND FOR BOUILLON STRAINER

Item #	Ø"	H"	Wt lb.
116515	5 1/2	8 7/16	1



EXOGLASS® SIEVE STRAINER

Item #		Ø"	H"	Wt oz.
017364	Small grid	8	7 5/8	12
017365	Medium grid	8	7 5/8	12



FUNNEL

Stainless steel.

Item #	Ø"	Tube	Wt oz.
116220	4 3/4	1 1/2	4



PROPYLENE COLANDER

Light but sturdy.

Item #	Ø"	H"	Capacity
071452	12 5/8	5 2/3	2 7/8 qts.
071456	14 1/6	6 2/3	4 1/4 qts.



ALUMINUM CONICAL COLANDER

Dual handled, self standing colander. Hooped base. Used for draining foods of excess liquids.

Item #	Ø"	H"	Capacity	Wt
529560	23 1/2	13	70 3/4 qts	5 lbs. 6 oz.



SMALL STRAINER

Made of stainless steel, very nicely finished.

Item #	Ø"	Wt oz.
020420	2 3/4	2
020422	4	2
020424	6	6
020426	7	6



STAINLESS STEEL CHINA CAP

Perforated stainless steel. Made of 1 piece with 1/16" holes, flat handle, with hook on each side and holder.

Item #	Ø"	Wt oz.
017335	7 7/8	8
017337	9	10



STAINLESS STEEL COLANDER

Colander on base with two handles.

Item #	Ø"	Wt oz.
017241	8 1/6	5
017242	9 7/8	5 1/2



STAINLESS STEEL CONICAL COLANDER

With handles and plain edge. Sturdy, easy-to-clean design.

Item #	Ø"	H"	Capacity	Wt
713824	9 1/2	4 1/4	3 1/2	2 lbs. 8 oz.
713828	11	5	5 3/8	3 lbs.
713832	12 1/2	5 1/2	7 1/3	3 lbs. 4 oz.



SALAD SPINNER WITH TRANSPARENT LID:
COMPACT AND EASY TO SPIN

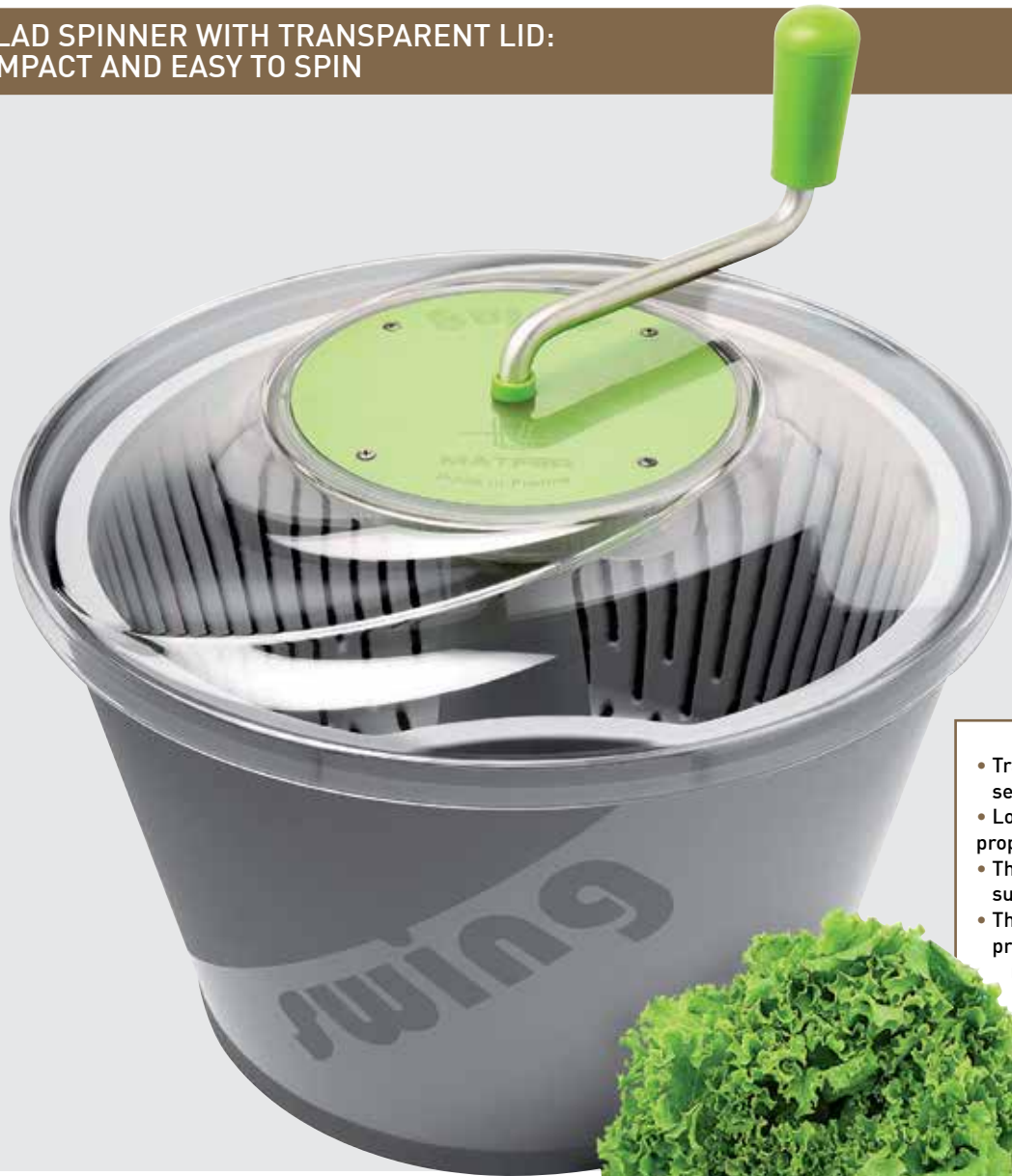

- Transparent lid allows you to see level of spin.
- Low, wide shape: provides proper stability.
- The wide aerated basket ensures effective spinning.
- The multiple gear system provides good flexibility and requires less effort when turning handle.

MATFER SWING SALAD SPINNER

Polypropylene body and basket with polycarbonate lid. Built for extra strength & durability. Supplied with the drainage tube.

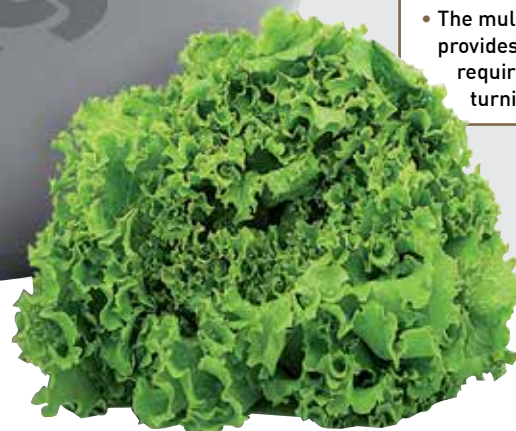

2 YEAR WARRANTY



LEARN MORE ABOUT THIS PRODUCT IN OUR CHEF LIFESTYLE BLOG.

SALAD SPINNER 2.5 GALLONS SWING XS

Item #	Capacity	Ø"
215582	2.5 gallons / 2 to 3 heads of lettuce	14 3/4

SALAD SPINNER 5 GALLONS SWING XL

Item #	Capacity	Ø"
215580	5 gallons / 4 to 5 heads of lettuce	18 1/8

SPARE PARTS

Item #	
215588	Kit gears + small cover + handle
215589	Gear kit



FISH SPATULA OR TURNER

Stainless steel. Straight blade with polypropylene handle. Dishwasher safe.

Item #	L"	W"	Wt oz.
072045	6 3/4	3 1/8	2



FISH SPATULA OR TURNER

Stainless steel. Flexible bevelled blade with wood handle.

Item #	L"	W"	Wt oz.
982045	12	1 1/2	2



ALL-PURPOSE TONGS

Stainless steel body.

Item #	Handle	L"
652014	STST	6 7/8
652015	STST	9 1/2
071694	RED PVC	9 1/2
071696	BLACK PVC	9 1/2
652016	STST	11 3/4
071698	RED PCV	11 3/4
652017	STST	15 3/4
071699	RED PCV	15 3/4



EXOGLASS® PELTON SPATULA

Item #	L"	Color	Top w"	Wt oz.
112420	12	gray	3 1/2	2
112421	12	blue	3 1/2	2
112422	12	red	3 1/2	2
112424	12	purple	3 1/2	2



FLAT CREPE SPATULA

Item #	L"	W"
071940	Made of beechwood	15 3/4
		1 7/8



SPATULA

Stainless steel flexible blade. Molded handle. Dishwasher safe.

Item #	L"
112650	7 7/8
112652	9 7/8
112654	11 7/8
112656	13 7/8



READ MORE ON THIS PRODUCT P. 43

EXOGLASS® BENT SPATULA

Item #	Overall L"	Blade L"	W"	Wt oz.
112686	17	11 3/4	1 1/2	8



OFFSET SPATULA

Stainless steel flexible blade, plastic handle. Dishwasher safe.

Item #	Blade L"	Wt oz.
112670	6 1/4	4
112672	8	4
112674	10 1/4	6
112676	12 1/4	7

MATFER BENT TURNER

Semi-flexible stainless steel blade, rounded edges. Black polypropylene molded handle. Dishwasher safe.



Item #		Blade L"	W"
112664	Plain	7 7/8	7
112666	Perforated	7 7/8	7



SEE CREPE PANS P. 90-192

CREPE SPREADER

Made of beechwood. For spreading crepe mix on machine.

Item #		L"	W"
071950	Flat	9 5/8	7
071945	Round	7 2/3	7





LEARN MORE ABOUT THIS PRODUCT
IN OUR CHEF LIFESTYLE BLOG.



MIXING BOWLS

Easy to clean.
Dishwasher safe.



HEMISPHERICAL BOTTOM MIXING BOWL

18/10 stainless steel. Round bottom. For mixing, whipping and storing.

Item #	Ø "	Capacity qts
703020	8	2.1
703025	10	3.7
703030	11 3/4	6.9
703035	13 3/4	10.6
703040	15 3/4	15.8



GREAT WITH SILVEO SPATULA SCRAPER P. 116



HEMISPHERICAL BOWL

White polypropylene with flat bottom. -4°F to 212°F.

Item #	LID	Ø "	Capacity qts
116451	116351	7 1/2	1
116452	116352	9 1/2	2.5
116453	116353	11	4.5
116454	116354	12 3/4	6
116455	116355	14 1/4	9
116456	116356	15 3/4	13

FLAT BOTTOM MIXING BOWL

18/10 Stainless steel. For mixing, whipping and storing.

Item #	Ø "	Capacity qts
702616	6 1/3	1
702618	7	1.6
702620	8	2.1
702622	8 3/4	2.6
702624	9 1/2	3.7
702626	10 1/4	4.7
702628	11	5.8
702630	11 3/4	6.9
702632	12 1/2	8.4
702636	14 1/4	12.5
702640	15 3/4	17.4



STAND FOR MIXING BOWL

Non-slip base for hemispherical bowls. Adheres particularly well to work tops and holds bowls and basins in the ideal position for kneading, whisking and mixing. Suitable for 7 3/4" to 15 3/4" Ø bowls.

Item #	Wt oz.
703019	4



GRADUATED PITCHER

With spout and handle, made of translucent polypropylene, graduated in 1/10 liter. Dishwasher and microwave safe.



Item #	H"	Litre	Wt oz.
251001	6 1/2	1	4
251003	9 1/4	3	4
251005	10 1/2	5	4

SUGAR MEASURING POURER

Cover and spout made of stainless steel, glass container. The spout enables easy pouring of sugar for one portion at a time. Economical and hygienic.



Item #	Ø"	H"	Wt oz.
061410	3	4 1/4	10



FAT SEPARATOR JUG

Jug to separate fat from juices by decanting. The pouring spout from the base of the jug enables the juices to be collected. SAN graduated. Dishwasher safe.

Item #	Ø"
251010	4 3/4



SEE THERMOMETERS P. 90-91



SYRUP DENSITY METER TEST TUBE

Made of stainless steel 18/10.

Item #	Ø"	H"
250112	1 3/8	6 7/8



BOTTLE FOR RUM SPRAYING ON BABA CAKES
Perforated cap.

Item #	Capacity oz.
116430	36



OIL SPRAYER

Sprays a thin uniform oil layer. Ideal for dressing salads, oiling meat and fish, or greasing trays, pans and molds. Manual air pump. Fitted with filter for spiced oils. Glass body and stainless steel pump.



Item #	Ø"	H"	Capacity oz.	Wt oz.
661404	2 1/2	7 1/6	5 3/4	8



24 HOUR 3 FUNCTION DIGITAL TIMER

Digital display and magnetized back with clip. Supplied in a blister pack. 3 functions: Seconds countdown timer. Stopwatch. 24-hour clock.

Item #	L"	W"
250602	2	2 7/8



20 HOUR DIGITAL TIMER MAGNET BACK & CLIP

Digital display. Magnetized back with clip. Easily fits in a pocket. Supplied in a blister pack.

Item #	L"	L"
250601	2	2 7/8



- Made of stainless steel.
- Reinforced mechanism and squeeze handles for stronger tool.

ICE CREAM SCOOP

Item #	Ounce/Scoop	Ø"	Wt oz.
670330	1 1/2	2	7
670316	2	2 1/4	7
670308	4	3 1/4	7



OVAL ICE CREAM SCOOP

Stainless steel, professional model.

NEW!

Item #		L"	W"	H"
670389	oval	2 3/8	1 7/8	1 5/8



Set includes 4 sizes of spoons:

- 1/5 Teaspoon - 1 ml.
- 2/5 Teaspoon - 2 ml.
- 1 Teaspoon - 5 ml.
- 1 Tablespoon - 15ml.



MEASURING SPOONS

Made of stainless steel. Practical for rapid measuring.

Item #	Wt oz.
072029	4



Customize with your logo from 1000+ units



BAG CLIP

To easily re-seal opened bags of ingredients to keep the contents free from contaminants. Polyamide. Heat resistant up to 100°C. Pack of 10 units.

Item #	L"	W"	H"
118991	2 1/2	1 1/10	2 1/4



ONE PIECE ALUMINUM INGREDIENT MEASURING SCOOP

One piece, nearly unbreakable, 100% hygienic.

Item #	L"	Capacity oz.
116201	7 1/3	3 3/4
116202	8 1/4	6
116208	9 3/4	9 3/4
116204	12 1/4	22



CUTTING-EDGE DESIGN AND TECHNOLOGY FOR INCOMPARABLE RESULTS IN THE KITCHEN.



LEARN MORE ABOUT THIS PRODUCT IN OUR CHEF LIFESTYLE BLOG.



MICROPLANE GRATERS

These stainless steel graters are manufactured to provide long-lasting blades with a razor-sharp cut. Foods are cut without being torn, retaining all their flavor and aroma.

Microplane® graters enable you to grate effortlessly soft or hard cheeses, vegetables, citrus zest, nuts, spices and condiments, mushrooms, chocolate, etc. Graters supplied with blade cover for storage.



- Graters supplied with blade cover for storage.
- Hanging ring.
- Dishwasher safe.
- Blade covers hand wash only.

1. ORIGINAL ZESTER

Use to zest oranges, lemons, limes and other citrus.

Item #	Dimensions"	Wt oz.
440001	12 x 1 1/3 x 1/3	3

THE CHEF'S ESSENTIAL GRATERS

Ergonomic black soft-touch handle with anti-scratch rubber stops at the end of the grater:

2. PREMIUM SPICE GRATER

Still a classic... only better. This new version of our spice grater tackles even the hardest spices like nutmeg with ease. Ideal for grating a touch of fresh cinnamon or chocolate over the top of your hot drink.

Item #	Dimensions" (L x W x H)	Wt oz.
186604	9 x 1 1/2 x 1	3

3. CLASSIC ZESTER/GRATER

Use to zest citrus, hard cheese and ginger.

Item #	Dimensions"	Wt oz.
440020	12 x 1 5/6 x 1	4

4. PREMIUM ZESTER/GRATER

Use to zest oranges, lemons, limes and other citrus.

Item #	Dimensions"	Wt oz.
446020	12 x 1 5/16 x 1	4





MICROPLANE GINGER TOOL

Crafted using original Microplane stainless steel etched blades, the seriously sharp and efficient 3-in-1 Ginger Tool is the only gadget needed when cooking or baking with ginger. The rasp-like tool features a peeler on the side to quickly remove the peel of knobby, fresh ginger root. A wide panel incorporating Microplane's top-selling Fine blade, makes fast work of grating ginger, and a razor-sharp, angled blade towards the bottom of the tool thinly slices ginger with ease and precision.

Item #	Dimensions" (L x W x H)	Wt oz.
216130	12 x 4 x 1/2	3 1/2



MICROPLANE WHITE ROTARY GRATER

The New Microplane Rotary Cheese Grater features Microplane's renowned etched technology to give you a razor sharp blade that effortlessly turns hard cheeses like Parmesan, Asiago, Romano and many more into fine, lacy wisps of delicious flavor! This tool is a perfect tabletopper for professional setting.

Item #	Dimensions" (L x W x H)	Wt oz.
215438	8 3/8 x 3 1/2 x 3 1/2	8



MICROPLANE 7-IN-1 ULTIMATE BAR TOOL

- Muddler with protective cover in place
- Stainless steel blade includes : hole at top to stir drinks / strainer holes along flat edge / partial paring knife to score and cut / channel knife for medium twists
- Peeler to make flaming orange twists is included on base of handle, under protective cover.

Item #	Pack of 6
183896	



MICROPLANE YELLOW ULTIMATE CITRUS TOOL

Zests citrus and has a large and small blade for making garnishes.

Item #	Dimensions"	Wt oz.
434620	9 1/2 x 2 3/4 x 7/8	4

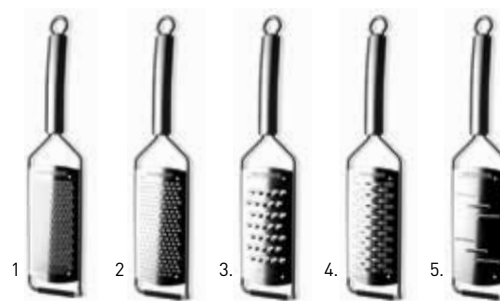

MICROPLANE PROFESSIONAL GOURMET GRATERS

Made of stainless steel. Ergonomic wide graters, black soft touch ergonomic handle with non-slip rubber stoppers for improved stability.

- 1. FINE GRATER**
Use to zest citrus, grate hard cheeses, spices, chilies & ginger.
- 2. COARSE GRATER**
Use to grate hard cheeses, coconut, carrots garlic & chocolate.
- 3. EXTRA COARSE GRATER**
Use to grate zucchinis, potatoes, soft cheeses, carrots & cabbage.
- 4. RIBBON GRATER**
Use to grate chocolates, coconut, soft cheeses, zucchini & onion.
- 5. SHAVER**
For shaving chocolate, hard cheeses, cucumber, garlic & ginger.

Item #	Dimensions"	Wt oz.
438004	13 x 2.9 x 1	7
438000	13 x 2.9 x 1	7
438008	13 x 2.9 x 1	7
438002	13 x 2.9 x 1	7
438006	13 x 2.9 x 1	7



MICROPLANE COARSE BLACK GRATER

Use to grate hard cheeses, coconut, carrots, garlic and chocolate.

Item #	Dimensions "	Wt oz.
444001	10 3/4 x 3 3/8 x 3/4	4

MICROPLANE FINE BLACK GRATER

Use to zest citrus, grate hard cheese, nuts, ginger and garlic.

Item #	Dimensions "	Wt oz.
444002	10 3/4 x 3 3/8 x 3/4	4



MICROPLANE CHEESE MILL

Comes with a fine and coarse blade for grating a variety of hard cheeses.

Item #	Dimensions "	Wt oz.
448007	2 3/4 x 2 3/4 x 6 1/2	15
448907	Stainless steel 2 3/4 x 2 3/4 x 6 1/2	14



MICROPLANE HERB MILL

Twist top to cut herbs like parsley, dill, cilantro and sage. Hundreds of tiny scissors on blades cut herbs without bruising or blemishing.

Item #	Dimensions "	Wt oz.
448006	2 3/4 x 2 3/4 x 6 1/2	14



ROTARY CHEESE GRATER

Stainless steel.

Item #	L "
215437	7 7/8



MATFER SHARP BLADE GRATERS

Zester can be used for lemon, ginger. Medium grater for fruits. Large grater for chocolates, hard cheese.

Item #	Dimensions "	Total L "	Wt oz. "	
216011	4-1/3 x 1 1/2	13	2	Zester 2 mm
216012	4-1/3 x 1 1/2	13	2	Grater - medium 4 mm
216015	4-1/3 x 1 1/2	13	2	Chocolate grater 22 mm



ELITE BOX GRATER

The Microplane® Elite Box Grater features five popular blade styles: fine, coarse, ribbon, ultra coarse and a slicer blade. The ergonomic design has a non-slip handle and rubberized base for stability and ease of grating. The convenient slide-out catch plate holds grated foods and the measuring feature helps you monitor the volume.

Item #	Capacity	Dimensions (L x W x H)	Wt oz.
186614	2 1/2 cups	5 x 3 1/2 x 10 1/5	13 1/2

5 YEAR WARRANTY

FOUR-SIDED MANUAL GRATER

Made of stainless steel.

Each side has a different size grating surface.



Item #	Depth "	H "	W "	Wt oz.
215431	3 3/8	7 1/2	4 1/8	6





CHEF CALUM FRANKLIN
LONDON - UK

SLICING



MATFER MANDOLINES : IDEAL FOR PRECISE AND EVEN CUTTING IN TOTAL SAFETY



LEARN MORE ABOUT THIS PRODUCT
IN OUR CHEF LIFESTYLE BLOG.

MATFER MANDOLINE 2000S WITH SAFETY PUSHERS

Frame and safety guard/pusher are made of heat resistant, nonporous composite fiberglass.

Blades are crafted from carbon stainless steel.

The mandoline's slicing blade has both a straight edge and serrated edge. The safety guard or pusher protects your hands from the blade. The julienne blades create vegetable/fruit sticks of various widths. The stainless steel guiding plate located on the upper section of the mandoline, adjusts to vary the thickness of the vegetable/fruit slices. The straight edge of the slicing blade is ideal for slicing a variety of foods from carrots and cabbage to lemons and potatoes. The serrated edge creates crinkle and waffle cuts. The three julienne blades create classic julienne strips in three different thicknesses 1/8", 3/16" or 3/8", length 15 1/2", width 5 1/4". Includes a set of 3 julienne blades: 30, 18 and 10 teeth.

Comes with a rotary and flat pusher.

Item #	L"	W"	Wt
215060	15 1/2	5 1/4	3 lbs. 7 oz.



SPARE PARTS

Item #	Description	Spacing"
215070	Julienne blade	# of Teeth, 30, 1/8
215072	Julienne blade	# of Teeth, 18, 3/16
215074	Julienne blade	# of Teeth, 10, 3/8
215086	Set of 4 rubber feet	2 oz.
215085	Reversible straight/waffle blade /knob	
215068	Set of 3 Juliennes	30 teeth, 1/8 spacing
		18 teeth, 3/16 spacing
		10 teeth, 3/8 spacing
215065	Complete rotary pusher for mandoline 2000s	

WARNING: THE MATFER MANDOLINE IS A SLICING TOOL AND AS WITH ALL SLICING TOOLS IT MUST BE HANDLED WITH CARE. IT MUST NOT BE LEFT WITHIN THE REACH OF CHILDREN. USE VEGETABLES GRADED MEDIUM SIZE, FIRM WITHOUT BRUISES.



WARNING: THE MATFER MANDOLINE IS A SLICING TOOL AND AS WITH ALL SLICING TOOLS IT MUST BE HANDLED WITH CARE. IT MUST NOT BE LEFT WITHIN THE REACH OF CHILDREN. USE VEGETABLES GRADED MEDIUM SIZE, FIRM WITHOUT BRUISES.



LEARN MORE ABOUT THIS PRODUCT
IN OUR CHEF LIFESTYLE BLOG.

MATFER STAINLESS STEEL MANDOLINE

Slices, sticks, potato chips, wafers, French fries, matchsticks, etc. in seconds and in 3 different thickness cuts. Different cuts obtained by:

- adjusting cut thickness (up to 10 mm)
- selecting straight or serrated blade,
- selecting one of the 3 blades delivered with the mandoline slicer (3, 5 and 10 mm).

With the concept blade holders delivered with the Matfer Mandoline, you easily switch from 10 to 30 Julienne blades in a few seconds and revert to the carver, waffle or plain central blades in a simple operation. Optional, stainless steel pusher.

SPARE PARTS (For items 215000 and 215001)

Item #	Description
215005	Pusher
215010	Julienne blade: # of Teeth, 30, 1/8"
215112	Julienne blade: # of Teeth, 18, 3/16"
215115	Julienne blade: # of Teeth, 10, 3/8"
215017	Foot Stand / Holder
215018	Large Plate
215021	Pusher Holder
215022	Pusher Plate
215023	Pusher Handle
215085	Reversible straight/waffle blade/knob

- Stainless steel 18/10 construction, blades in tempered steel.
- Stainless steel body, one-piece foot and handle, removable without tools.
- No screws and nooks anywhere to catch food.
- Each part is smooth and quick to dismantle.
- Easy to clean.
- Pusher does not limit the size of your vegetables and avoids waste by creating fewer vegetable heels.
- One handle to hold in position during the chef's work, a smooth inclined plane, which allows adjustment of the blades.
- After a long period of usage, you can sharpen the knives and correct the play of the blades for more precise cuts.



COMPLETE SET

Complete set with pusher, one straight blade, one waffle blade and set of 3 julienne blade : 30, 18 and 10 teeth.

Item #	Wt
215000	4 lbs. 4 oz.

Set includes : one straight blade, one waffle blade and set of 3 julienne blades : 30, 18 and 10 teeth. Pusher not included.

Item #	Wt
215001	3 lbs. 3 oz.

**INCLUDES:**

- Removable and interchangeable straight blade.
- Easy to fit julienne blade.
- Serrated blade.
- Pusher protector provides hand protection at all times.

WARNING: THE MANDOLINE IS A SLICING TOOL AND AS WITH ALL SLICING TOOLS IT MUST BE HANDLED WITH CARE. IT MUST NOT BE LEFT WITHIN THE REACH OF CHILDREN. USE VEGETABLES GRADED MEDIUM SIZE, FIRM WITHOUT BRUISES.

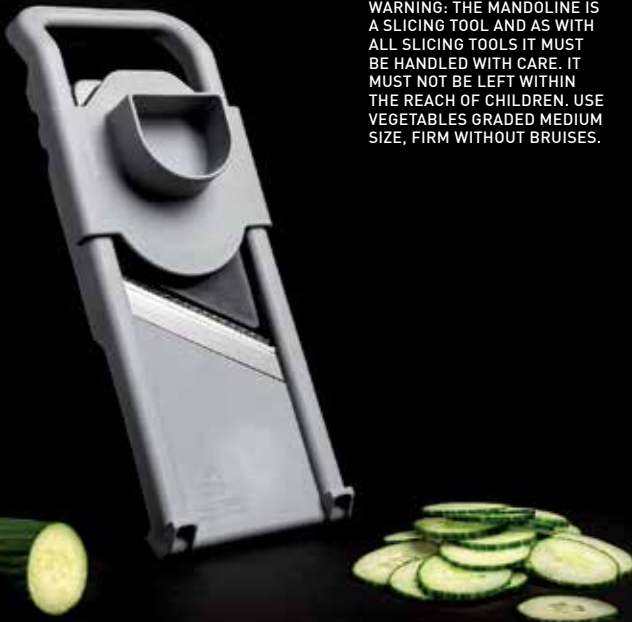
**MATFER MANDOLINE 1000**

Outstanding cutting edge and slanted blade, for perfect slicing.

- Made of composite material.
- Dishwasher safe.
- Compact and lightweight; free of any attached foot, it easily fits into a chefs' knife case.
- Using its indentation in the frame, secure it over a bowl or a pan and use it horizontally.
- Adjusting the cutting thickness (up to 6 mm) is accurate and easy by using a single wheel located under the machine's body.
- For cleaning maintenance, wash with hot water and dish soap.

COMPLETE MATFER MANDOLINE 1000 SET

Item #	Wt
215040	1 lb, 5 oz.

SPARE PARTS

Item #	Description	Wt oz.
215043	Straight blade	1
215044	Waffle blade	1
215045	Julienne blade	1
215046	Pusher	3

**BENRINER JAPANESE MANDOLINE**

Mandoline that is needed in every professional kitchen. Includes safety pusher and 3 interchangeable blades for a wide variety of garnishing. Flexible thickness adjustment with easy blade replacement will save a lot of time.

Item #	Model	L"	W"
186700	LITTLE BENI	12 1/2	3 1/2
NEW! 186703	Spare part : Fine Blade		
NEW! 186704	Spare part : Medium Blade		
NEW! 186705	Spare part : Coarse Blade		
186706	BIG BENI	13 7/8	5 1/8

BENRINER JAPANESE MANDOLINE - MASTER CASE

Item #	Model	
186700MC	LITTLE BENI	Master case 36 pieces
186706MC	BIG BENI	Master case 24 pieces

**BRON MANDOLINE**

Made of stainless steel, always ready within seconds. The safety guard is guided on its rails and allows both slices and stick cuts. Set includes serrated blade for waffled cuts, straight blade, 2 Julienne blades (ships with 1/8" and 3/8"), 4 non-skid stands for a perfect stability.

Item #	Description
215030-035	Complete set Stainless Steel Pusher + Blades
215029	Complete set Plastic Pusher + Blades
215030	Mandoline + Blades without pusher/guard

SPARE PARTS

Item #	Description
215035	Stainless Steel Pusher
215028	Plastic Pusher
BC-19638	Bron Mandoline 38 blade
BC-10644	Bron Mandoline 44 blade
BC-11660	Bron Mandoline 60 blade
990593	Waffle blade
990596	Straight blade



SIMPLY TURN THE HANDLE AND IT SIMULTANEOUSLY PEELS, CORES AND SLICES



WARNING: THE MATFER APPLE PEELER IS A SLICING TOOL AND AS WITH ALL SLICING TOOLS IT MUST BE HANDLED WITH CARE. IT MUST NOT BE LEFT WITHIN THE REACH OF CHILDREN. USE APPLE GRADED MEDIUM SIZE, FIRM WITHOUT BRUISES. TO OBTAIN OPTIMUM SLICING DO NOT TURN THE HANDLE QUICKLY.



- Totally rust free since it is made of EXOGLASS® composite material and stainless steel.
- Cutlery stainless steel blades for perfect peeling.
- The settings can be changed according to the variety of apple : Adjustable peeling thickness, core diameter and peeler pressure.
- Place a container (not included) under the tool to collect cores and peels.
- Delivered with a clamp to fix the peeler to the worktop.
- Can also be screwed to the worktop.

APPLE PEELER/SLICER/CORER

Delivered with suction cup, use it anywhere. Peels, slices and cores simultaneously.

Item #	Description	Wt lbs.
215155	Apple peeler	2
215158	Blade for apple peeler	

MATFER APPLE PEELER / SLICER / CORER

For any type of round fruit: designed for professional use. Produces only 1/8" thick slices.

Item #	Wt
215250	4 lbs. 2 oz.

SPARE PARTS FOR 215250

Item #	Description
215255	Peeler blade
215256	Corer/slicing blade



MATFER PREP CHEF

A SINGLE APPLIANCE FOR CHOPPING, SLICING AND CRUSHING



LESS BULKY

MATFER PREP CHEF MINI

Benefits :

- Compatible with all Prep Chef tools, including the masher and onion cutter.
- Comes with one GN pan 100mm deep (4").

Specifications:

Composite material base.
Stainless steel rods on springs.
Detachable handle

Item #	L"	W"	H"
215609	9 7/8	7 7/8	13 1/2





SLICING

MATFER PREP CHEF



RECOMMENDED TO USE WITH CUT PREVENTIVE GLOVES (ITEMS SEE P. 226).



- Purchase BASE (item 215610).
- Purchase blade blocks and pushers (KITS) based on your needs and work.
- We offer all models in the basic version. Industrial dishwasher safe.

ERGONOMIC

Large handles for ease and safety of use.

MULTI-PURPOSE

Easily interchangeable pusher, no tools required.

COMFORTABLE

Pusher return springs for easy use.

EFFICIENT

Tempered steel blades for clean, easy cutting. Cutting results guarantee impeccable product presentation and optimal conservation. Interchangeable blade block.

HARDWEARING

Robust composite body.

PRACTICAL

Segments collection in a container to be placed directly under the appliance (GN 1/2 container max 100mm deep, not supplied).



LEARN MORE ABOUT THIS PRODUCT IN OUR CHEF LIFESTYLE BLOG.

MATFER PREP CHEF - BASE

Sold separatly

Designed with a single base on which all the tools (blade blocks and pushers) are interchangeable without tools.

WARNING: THE MATFER PREP CHEF IS A SLICING TOOL AND AS WITH ALL SLICING TOOLS IT MUST BE HANDLED WITH CARE.

IT MUST NOT BE LEFT WITHIN THE REACH OF CHILDREN, USE VEGETABLES GRADED MEDIUM SIZE, FIRM WITHOUT BRUISES.

Item #	L mm	W mm	H mm
215610	15 3/4	15 3/4	20

CHOPPING

9 CUTTING POSSIBILITIES

Choose your tools to suit your needs, with a base that adapts to all of them.

The Matfer Prep Chef has been designed so that all tools (blade blocks + pushers) are manually interchangeable.



FRENCH FRIES CUTTER

Item #	Description
215626	French Fries 8 x 8 mm
215627	French Fries 10 x 10 mm

LARGE FRENCH FRIES CUTTER

Item #	Description
215628	French Fries 8 x 16 mm

TOMATOES AND CITRUS FRUITS WEDGER

Item #	Description
215616	6 segment sectioner
215618	8 segment sectioner

CHERRY TOMATO DIVIDER

Item #	Description
215615	4 segment sectioner

CORER-SEGMENTER

Item #	Description
215619	Corer-segmenter

CHEESE PORTIONER

Item #	Description
215838	8 portions

EGG WEDGER SEGMENTER

Item #	Description
215836	6 sections

ONION CUTTER

NEW!

Available in August 19

ONIONS CUTTER (with base)

Benefits:

- Speed: Chops 1 kg (2 lbs.3oz) of onions into cubes in under a minute!
 - Minimal effort thanks to the large lever.
 - Results guaranteed for halved onions.
- For a finer chop, cut the onions into thick slices (4 to 6).

Specifications:

A tripod stand compatible with the masher tool.
Detachable tool. Lever and grinder can be disassembled.
8 x 8 mm (1/3 x 1/3) grill moulded into the tool.

Item #	L"	W"	H"
215650	16	15 7/8	13 1/6
215651	Onion cutter (blade block only with base)		

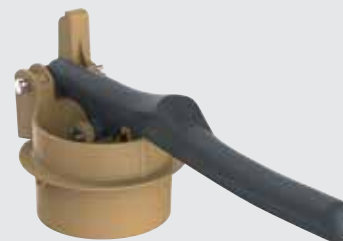

Color not contractual





SLICING



4 BLADE BLOCKS



CHEESE SLICE-CUTTING PORTIONER

Item #	
215851	Slice 8 mm



EGG SLICING PORTIONER

Item #	
215831	Slice 5 mm



SLICER

Item #	
215611	5 mm block slicer
215613	5 mm semi-circle slicer



Color not contractual



LEARN MORE ABOUT THIS PRODUCT IN OUR CHEF LIFESTYLE BLOG.



NEW!

SUPPORT FOR ONION CUTTER AND POTATO MASHER Comes with a spoon for easy receptacle filling.

Item #	L"	W"	H"
215642	15 3/4	15 4/5	9 1/3



LEARN MORE ABOUT
THIS PRODUCT IN OUR
CHEF LIFESTYLE BLOG.

VISIT OUR BLOGS TO DISCOVER MORE RECIPES,
TOOLS, COOKING TIPS AND CHEF SPOTLIGHTS!

Blog: <http://www.matferbourgeatusa.com/blog>

SPARE PARTS

MATFER PREP CHEF CORER-SEGMENTER

Maximum diameter of fruit: 90 mm. Core diameter: 25 mm.
8 segments.



Item #	Size
215758	Block slicer
215768	Pusher

ORIGINAL CUTS

MATFER PREP CHEF FRENCH FRIES CUTTER



Item #	Size
215734	8 x 8 mm blade block
215735	10 x 10 mm blade block
215744	8 x 8 mm pusher
215745	10 x 10 mm pusher

MATFER PREP CHEF WIRE OR EGG WEDGER & SLICER



Item #	Description
215841	5 mm block for egg slicer
215861	8 mm block for wire slicer
215866	Wire pusher for egg wedger 6 segments
215868	Wire pusher for wire wedger 8 segments

MATFER PREP CHEF SEGMENTER



Item #	Size
215736	6 segment blade block
215738	8 segment blade block
215746	6 segment blade pusher
215748	8 segment pusher

MATFER PREP CHEF SEMI-CIRCLE SLICER

Specially designed to slice tomatoes for use in sandwiches. With large tomatoes, half-slices are often better suited and easier to use in sandwiches.



Item #	Description
215732	Semi-circle slicer
215731	5 mm blade block slicer
215742	Pusher for whole and semi-circular slices

Item #	Description
215790	2 screws
215791	2 springs
215792	3 suction feet



CRUSHING



A SINGLE MOTION, 3 TIMES QUICKER

3 TIMES QUICKER THAN A MILL! ⁽¹⁾

LIGHTER, AIRIER PUREES AND MASHES ⁽²⁾

(1) Time including assembly, loading, preparation and cleaning.
 (2) As compared with a mill with a 1 / 10 grille.

A WORK-SAVER

Crush potatoes with A SINGLE MOTION

GRID Perforations Ø 1/8

COMPATIBLE With casserole dishes of up to Ø 11

STABILITY Thanks to tripod support



POTATO MASHER PREP CHEF (base + blade block)
Comes with a spoon for easy receptacle filling.

Item #	L"	W"	H"	H high handle
215640	16 1/8	15 7/8	13 1/6	24 7/8
NEW! 215641	Blade block can be used with Onion Cutter base [215651]			
NEW! 215642	Can be used for Potato Masher and Onion Cutter			
	15 3/4	15 3/4	9 1/3	
215794	Masher body			
215795	Masher lever			
215796	Masher plate			
215797	Masher lever, holder pin 3 1/6. Length 3 1/6.			
215798	Masher lever, holder pin 2 1/3. Length 2 1/4.			
215799	2 stainless pin nuts			
215800	2 holder stop			



PREP CHEF BLADE BLOCK STORAGE SHELF
Capacity: 3 blade blocks and a pusher. Place on a work surface or mount on a wall. Screws not included, heat-formed ABS.

Item #	L"	W"	H"
NEW! 215690	18 3/4	8 1/6	6



SPIRAL VEGETABLE SLICER "LE ROUET"

Makes vegetable strings to weave decorative mats, coleslaw or other vegetable salads.

Item #	Wt
LER-4030CLR	9 lbs. 2 oz.



- Housing and pusher made of stainless steel.
- Knife holder made of cast aluminum, tempered stainless steel blades.
- Comes with two sets of 3 blades: 5/64", 1/8" and 1/4".
- Clamp axle, straight and fluted blade.

WARNING: THE SPIRAL VEGETABLE IS A SLICING TOOL AND AS WITH ALL SLICING TOOLS IT MUST BE HANDLED WITH CARE. IT MUST NOT BE LEFT WITHIN THE REACH OF CHILDREN. USE GRADED MEDIUM SIZE VEGETABLES, FIRM WITHOUT BRUISES. TO OBTAIN OPTIMUM SLICING DO NOT TURN THE HANDLE QUICKLY.



SPIRAL VEGETABLE SLICER "LE ROUET"

Made of stainless steel with cast ABS removable frame and blade holder. Ideal for cutting vegetables in continuous strips, delivered with fixing clamps and 3 blades: 3/64", 3/32" and 3/16" (1 mm, 2 mm and 4 mm.)

Item #	L"	W"	H"
215131	14 1/2	5 1/2	10

SPARE PARTS

Item #	
215121	1 mm (3/64") cutting blade
215132	2 mm (3/32") cutting blade
215124	4 mm (3/16") cutting blade
210213	Set of 3 blades: 1, 2 and 4 mm



POTATO SPIRAL CUTTER

Small utensil to make Ø 3/8" spirals of potato. When steamed or deep fried, these spirals make original decoration for dishes. Stainless steel.

Item #	L"
120939	9 1/2

SPARE PARTS FOR LER-4030CLR

Item #	
LER-4058	Blades holder for "Le Rouet"
LER-4043	Verticablade L5/64" (2 mm) spacing
LER-4044	Verticablade L1/12" (3 mm) spacing
LER-4045	Verticablade L1/4" spacing (6 mm)
LER-4048	Straight blade with screw and tools 1/4" spacing



TURNING VEGETABLE SLICER

Safe and simple to operate with rotating lever vegetable slicer will help anyone prepare beautiful garnishings. Comes with 3 interchangeable blades: fine, medium and coarse.

Item #	L"	W"	H"
186702	11	4 1/2	6 1/2

Item #	
186702MC	Turning Vegetable Slicer - Master Case (8 pieces)



© Eric Fenot - Le grand cours de cuisine de l'École Ferrandi

FOOD MILLS

Known in France as a “moulin à légumes”. This classic low-tech tool treats food more gently than food processors.



- It purees and strains ingredients at the same time, producing a perfectly smooth, even texture.
- When you turn the crank, a rotating blade pushes foods through a perforated disk into a bowl, leaving unwanted fibers and particles behind.
- Cooks make the most of autumn’s root vegetables by using a manual food mill to create flavorful purees – the perfect accompaniment to roasted poultry and meats.



STAINLESS STEEL NO. 3 FOOD MILL

Equipped with 3 interchangeable grids of fine, medium and large grind.

Item #	Ø"	Wt
X3	12 1/4	4 lbs. 2 oz.

Item #	Description	Wt oz.
X3015	Fine grid 1/16", 1.5 mm	4
X3025	Medium grid 3/32", 2.5 mm	4
X3040	Large grid 3/16", 4 mm	4

X3-HANDLE Blue handle



STAINLESS STEEL NO. 5 FOOD MILL

Made of stainless steel, with a system of double milling on the bottom and sides. Cap. 8 quarts, produces 10 lbs. per minute, fits on any pan or bowl with a Ø of 10 1/4" to 24". Comes with 1/8" basket-shaped grid.

Item #	Wt
X530	7 lbs. 7oz.

Item #	Description	Wt oz.
X5010	Grid 3/64", 1 mm	4
X5015	Grid 1/16", 1.5 mm	4
X5020	Grid 3/32", 2 mm	4
X5030	Grid 1/8", 3 mm	4
X5040	Grid 3/16", 4 mm	4

STAINLESS STEEL FOOD MILL

Equipped with 3 interchangeable grids of fine, medium and large grind.

Item #	Ø"	Wt
N3002X	7 5/6	1 lb.
N3004X	9 1/2	1 lb. 12 oz.





ROTARY FLOOR STAND FOOD MILL

High performance, professional, tinned steel food mill - 15 qts.



- It has an output of 22 lbs. per minute.
- Perfect for mashing, purees and soups.
- Horizontal stand lets you put a container directly beneath the food mill.
- Choose the grid that suits your needs.

Item #	Grid Ø "	H "	Wt lbs.	Capacity qts	Top Ø "
P1000	8	31 1/2	31	15	15 1/2

GRIDS

Item #	Size
P10010	3/64", 1 mm
P10015	1/16", 1.5 mm
P10020	3/32", 2 mm
P10030	(most commonly used) 1/8", 3 mm
P10040	3/16", 4 mm



TIN-PLATE NO. 5 FOOD MILL

Made of tin-plate, with a system of double milling on the bottom and sides. Cap. 8 quarts, produces 10 lbs. per minute, fits on any pan or bowl with a Ø of 10 1/4" to 24". Comes with 1/8" basket-shaped grid.

Item #	Ø "	Wt
M530	14 1/4	5 lbs. 9 oz.

GRIDS

Item #	Grid	Wt oz.
M5010	3/64", 1 mm	4
M5015	1/16", 1.5 mm	4
M5020	3/32", 2 mm	4
M5030	1/8", 3 mm	4
M5040	3/16", 4 mm	4



TIN-PLATE NO. 3 FOOD MILL

Equipped with 3 interchangeable grids of fine, medium and large grind.

Item #	Ø "	Wt
S3	12 1/4	4 lbs. 2 oz.

GRIDS + SPARE PARTS

Item #	Description	Wt oz.
S3015	Fine grid 1/16", 1.5 mm	4
S3025	Medium grid 3/32", 2.5 mm	4
S3040	Large grid 5/32", 4 mm	4
S3-HANDLE	Green handle	



IMPERIA ELECTRIC PASTA MACHINE

Ideal for restaurants and group caterings.



Item #	L"	W"	H"
073170	12 1/2	11 3/4	10 1/4



CYLINDERS SUPPLIED SEPARATELY.



- Chromed steel body.
- Hourly output: approx 12kg. (26 1/2 lbs.)
- Ø of sheeter cylinders: 8 3/4".
- Max thickness of pasta dough: 5/13".
- Toughened steel countersunk cogs.
- Numbered knob to set dough thickness (10 settings).
- Patented affixer to ensure perfect adhesion to work surface.
- Safety: mixer stops automatically when the lid is opened.
- 110 V. 35 lbs.



CYLINDERS FOR ELECTRIC AND MANUAL IMPERIA PASTA MACHINES

Item #	Description	W	Wt
073181	Spaghetti #0	1/32" 2mm	
073180	Angel Hair #1	1/64"/1.5 mm	4 lbs. 10 oz.
073182	Tagliatelli #2	1/32"/2 mm	4 lbs. 13 oz.
073184	Trenette #3	1/24"/4 mm	4 lbs. 10 oz.
073186	Fettuccine #4	1/16"/6.5 mm	7 lbs.
073183	Lasagnette #5	12 mm	4 lbs. 10 oz.

SPARE PARTS

Item #	Description
073171	Preventive Maintenance Kit
IMP-CLAMP	Clamp
IMP-GEARS	Replacement Plastic Gears
IMP-KNOB	Knob
IMP-HANDLE	Handle
IMP-LGHANDLE	Large Handle

© Eric Fenot - Le grand cours de cuisine de l'Ecole Ferrandi



- All moving parts are made of drilled and tempered steel.
- Makes approximately 26 1/2 lb. of pasta per hour.
- With knob to adjust thickness of dough (10 different positions possible).
- A patented clamp assures a perfect grip on the countertop.
- With a rolling mill cylinder of 8-5/8" and pasta dough with a maximum thickness of 3/8".
- Four interchangeable cylinders are available.
- Strong clamp included.
- Pasta machine without cylinder.

**TITANIA MANUAL PASTA MACHINE**

Monobloc chrome-plated steel machine with 3 cutters: smooth, 2mm fettuccine and 6.5mm tagliatelle with a detachable handle and table clamp.

Item #	L"	Depth	H"
073140	7 1/2	6 3/10	4 7/10

**IMPERIA 150 MANUAL PASTA MACHINE**

The most multi-purpose pasta machine, can be used with various multi-purpose interchangeable cutters. Width of cutters and rolling mill: 143mm.

The thickness of the pasta can be adjusted at the push of a button.

A smooth fixed cutter and a detachable double cutter: 2mm fettuccine and 6.5mm tagliatelle. Chrome-plated steel rollers.

Item #	L"	W"	H"
073141	7 1/2	7	6 1/3

ACCESORIES FOR IMPERIA 150 AND TITANIA PASTA MACHINES

Item #			L"	W"	H"
073146	VERMICELI CUTTER	Easy to remove and interchange cutters	6 7/8	2 1/3	2
073147	SPAGHETTI CUTTER	Easy to remove and interchange cutters	6 7/8	2 1/3	2
073149	TAGLIATELLE CUTTER	Easy to remove and interchange cutters	6 7/8	2 1/3	2
073150	TRENETTE CUTTER	Easy to remove and interchange cutters	6 7/8	2 1/3	2
073151	FETTUCINE CUTTER	Easy to remove and interchange cutters	6 7/8	2 1/3	2

073148 RAVIOLI CUTTER

With hopper and shaping roller to pre-cut ravioli and ensure perfect sealing on all 4 sides. Simple and handy to use, easy to clean.

5 7/8

3 7/8

3 1/8



IMPERIA R220 MANUAL PASTA MACHINE
Ideal for restaurants and corporate cafeterias.

Item #	Dpt	W"	H"	Wt lbs.
073175	8 1/2"	13	10	26



NEW! **PASTA DRYING RACK WITH 12 ARMS**
Made of beechwood. Can dry up to 2 lbs. of pasta.

Item #	H"
073229	13 3/8



- Pressed aluminum mounted on a steel base with rubber feet for perfect adhesion.
- Supplied with wooden rolling pin.
- Ravioli dimensions: square 1 3/8" x 1 3/8", domed squares 2" x 2" / Ø 1 1/6".



IMPERIA RAVIOLI MOLD

Item #		L"	W"
073194	12 domed square raviolis	13 2/3	5 1/2
073200	36 square raviolis	10 2/3	4 1/8
073195	24 square raviolis	12	5 1/2



NEW!

PIZZA CUTTER

Pizza cutting wheel. Stainless-steel.

Item #	Ø"	L"
141031	2 1/3	8



MICROPLANE RED PIZZA CUTTER

Full 1.5" of clearance means you can cut through the deepest dish pizzas with ease. Removable blades for easy cleaning.

Item #	Dimensions"	Wt.oz.
448105	6 1/2 x 5 1/8 x 1	9



RAVIOLI MOLDS

Set of 3 molds for ravioli, mini-calzone, and other pastries. Supplied with recipe book. Polypropylene molds. Dishwasher safe.

Item #		Ø"	Dimensions
073159	large	6 1/8	9 1/2" x 6 7/8" x 1 1/2"
	medium	4 3/4	7 5/8" x 5 1/2" x 1 1/3"
	small	3 3/4	6 1/3" x 4 1/3" x 1"

**CHEESE GUILLOTINE**

To cut perfect wedges, with a clean cutting edge. Especially convenient for blue cheese or other soft cheeses. Plastic base.

Item #	Ø"	H"	Wt
072525	8 1/2	15	5 lbs. 4 oz.

SPARE PARTS

Item #	Description	Wt oz.
122013	Replacement handle	4
122012	Replacement spring	1
122011	Set of 10 Replacement wires	1

**CHEESE KNIFE**

Non-flexible stainless steel blade with two riveted handles.

Item #	Blade L"	Total L"	Wt
090347	15 3/4	25	1 lb. 2 oz.

**CHEESE OR FOIE GRAS WIRE SLICER**

Item #	L"	Wt oz.
122016	9 1/2	7

SPARE PARTS

Item #	Description	Wt oz.
122017	Pack of 10 replacement wires	1

**CHEESE / BUTTER WIRE**

Stainless steel wire and plastic handles. Set of 10.

Item #	L"	Wt oz.
122021	11 3/4	6
122031	31 1/2	12

**ADJUSTABLE TRUFFLE CUTTER**

Made of 18/10 stainless steel. Easy to use, with wheel for precise adjustment of slice thickness. Hanging hole for easy storage.



Item #	Wt oz.
072595	5

**ERGONOMIC TRUFFLE CUTTER**

Stainless steel base, blade and handle. Equipped with a very fine blade and highly precise thickness adjuster wheel, this cutter can be used for truffles and mushrooms. The reverse can be used to cut thin slices of cheese.

Item #	L"	W"	H"
215052	5 3/4	3 1/3	3 7/8

**CHEESE SLICER**

Slice thickness depends on the angle at which the slicer is held relative to the cheese. The lower the slicer is held, the thinner the slice. Cast aluminum with highly durable dishwasher safe coating.

Item #	L"	W"
072580	7 1/2	4 1/4

**SCALLOP SHELL KNIFE ERGOBLUE**

XL blade 110 mm (4 1/3"). Blue ergonomic handle.

Item #	L "
121050	8 7/8

**HERB SCISSORS**

With 5 stainless steel blades. Perfect for quick and gentle cutting of herbs.

Item #	L "	Wt oz.
120806	7 7/8	8

**DRAINAGE RACK FOR CHOPPING BOARDS**

Made of stainless steel. Ensures quick drying and proper ventilation and storage of boards. Holds six boards.

Item #	L "	W "	H "
139002	16	9	6

**CUTTING BOARD SCRAPER**

Plastic frame, steel blade. This scraper erases spots and grooves from the surface, leaving it smooth and clean. Steel interchangeable and reversible blade.

Item #	L "	W "	H "	Wt oz.
139005	8	2 3/4	5	13

SPARE PARTS

Item #	Description	Wt oz.
139006	Set of 2 spare blades	1

**SMALL FISH SCISSORS**

Scissors with short, pointed blade to open small fish with precision. Serrated blade to prevent slipping.

Item #	L "
121133	7 1/8

**FISH SHEARS**

Stainless steel blades with 1 serrated blade to avoid slipping on fish skin. Right-handed model.

Item #	L "
121134	6 1/3

**KITCHEN SCISSORS**

Stainless steel. Black plastic handles. For right or left hand use.

Item #	L "	Wt oz.
120802	8 1/4	4

**POULTRY SHEARS**

Blades made of stainless steel, handle in A.B.S. Black plastic handles. For right or left hand use.

Item #	L "	Wt oz.
120817	9 1/4	7

**MEZZALUNA BLADE**

Made of stainless steel and two plastic handles for easy and quick chopping of herbs or salads.

Item #	Description	L "	H "	Wt oz.
120451	single blade	8 1/2	3 5/8	11
090570	double blade	8 1/2		14



SUPERIOR QUALITY KNIVES ENSURING HIGH PERFORMANCE, LONG LASTING & COMFORT

WARNING: THE GIESSER MESSER KNIFE IS A SLICING TOOL AND AS WITH ALL SLICING TOOLS IT MUST BE HANDLED WITH CARE. IT MUST NOT BE LEFT WITHIN THE REACH OF CHILDREN. USE VEGETABLES GRADED MEDIUM SIZE, FIRM WITHOUT BRUISES.



LEARN MORE ABOUT THIS PRODUCT IN OUR CHEF LIFESTYLE BLOG.



- Best edge-holding guaranteed by high quality Chrome-Molybdenum Steel.
- Long lasting and reduced wear of the blade due to modern vacuum hardening technology: hardness 56 HRC Rockwell. High performance and easy re-sharpening of the edge.
- Non-slip, non-porous, sterilizable handles.
- Handle shape ensures user comfort regardless of the type of use.

GIESSER MESSER KNIVES

These knives combine tradition and quality, made in Germany by GIESSER MESSER, cutlery since 1865.



MULTI-PURPOSE KITCHEN KNIFE

Item #	Blade L"
182106	6



BONING KNIFE

Item #	Blade L"
182129	6 1/4



PARING KNIFE

Item #	Blade L"
182102	3 3/4



PARING KNIFE

Item #	Blade L"
182103	4



SERRATED KNIFE

Item #	Blade L"
182104	4 1/4



PEELING KNIFE

Item #	Blade L"
182101	2 1/4

**CHEFS KNIFE**

Item #	Blade L"
182112	7 3/4

**CHEFS KNIFE**

Item #	Blade L"
182113	10 1/4

**SERRATED/BREAD KNIFE**

Item #	Blade L"
182125	7

**SERRATED HAM KNIFE**

Item #	Blade L"
182119	9 3/4
182121	12 1/4
182122	14

**SERRATED/BREAD KNIFE**

Item #	Blade L"
182110	9 3/4

**HAM KNIFE**

Item #	Blade L"
182116	9 3/4
182118	12 1/4
182126	14

**FISH KNIFE**

Item #	Blade L"
182131	7

**SHARPENING STEEL**

Standard cut.

Item #	Blade L"
182151	12 1/4



GIESSER MESSER PREMIUMCUT CHEFS KNIVES

Arresting design, unbelievable sharpness and perfect workmanship combine to make this new knife series something very special. A first glance is all it takes for sparks to fly - you'll be fascinated by these tools in no time. High-quality chrome-molybdenum steel, tempered to a full 57 HRC, then finely polished and final sharpened by a master craftsman, guarantees long-lasting enjoyment.

To complement the three different blades, we offer a choice of four different handles made from carefully selected materials. Together with our extraordinary blades, they make for particularly valuable masterpieces.



- Rocking Chefs are tough guys with a soft core: Micarta handle, a natural material. Every handle is unique and makes you the real hero of the kitchen.
- "Rocking Chef" Ralf Jakumeit would go through fire for his absolute favorite!

PREMIUMCUT CHEFS KNIFE NO 1
Micarta Handle.

Item #	Blade L"
181901	7 3/4"



- The impressive design gets our hearts pumping. Red Diamond will take your breath away.
- The special manufacturing process creates one-of-a-kind handles, each one unique.
- Fire, meat and Red Diamond – what could be better?"

PREMIUMCUT CHEFS KNIFE NO 1
Red Diamond Handle.

Item #	Blade L"
181902	7 3/4"



- One look alone is enough to heighten all your senses and get ready for cooking.
- Exotic fragrances and spices mingle – you are one with your knife.

PREMIUMCUT CHEFS KNIFE NO 1 Spicy Orange Handle

Item #	Blade L"
181903	7 3/4"



- Tradition meets perfection.
- White cedar burl wood makes our Tree of Life handle a cut above.
- Thuja – also known as arborvitae or "tree of life" – has an extremely tough burl that makes using the knife an absolute pleasure.
- A handle of outstanding quality.

PREMIUMCUT CHEFS KNIFE NO 1 Thuja - Tree of Life Handle

Item #	Blade L"
181904	7 3/4"



GIESSER MESSER PREMIUMCUT BARBECUE KNIVES AND PREMIUMCUT FILLET KNIVES

The shape that curves to a point, the massive blade – just perfect for handling large cuts of meat, fish or vegetables. Experience the fascination of this knife during a fantastic grilled dinner together with your friends – and prepare to be admired.

Excellent preparation is the foundation of success. Fillet Knives feature a slightly flexible and curved blade, so you finish deboning and filleting easily, safely and quickly. A handle of outstanding quality: you're ready for an spectacular barbecue.



- Rocking Chefs are tough guys with a soft core. Every handle is unique and makes you the real hero of the kitchen.
- "Rocking Chef" Ralf Jakumeit would go through fire for his absolute favorite!"

PREMIUMCUT BARBECUE KNIFE NO 1
Micarta Handle. A natural material.

Item #	Blade L"
181911	11 3/4



- The impressive design gets our hearts pumping.
- Red Diamond will take your breath away: The special manufacturing process creates one-of-a-kind handles, each one unique.
- Fire, meat and Red Diamond – what could be better?"

PREMIUMCUT BARBECUE KNIFE NO 1
Red Diamond Handle.

Item #	Blade L"
181912	11 3/4



- One look alone is enough to heighten all your senses and get ready for cooking.
- Exotic fragrances and spices mingle – you are one with your knife.

PREMIUMCUT BARBECUE KNIFE NO 1
Spicy Orange Handle.

Item #	Blade L"
181913	11 3/4



- Tradition meets perfection.
- Thuja – also known as arborvitae or "tree of life" – has an extremely tough burl that makes using the knife an absolute pleasure.
- A handle of outstanding quality.

PREMIUMCUT CHEFS KNIFE NO 1
Thuja - Tree of Life Handle.

Item #	Blade L"
181914	11 3/4



- Rocking Chefs are tough guys with a soft core:
- Micarta handle, a natural material. Every handle is unique and makes you the real hero of the kitchen.
- "Rocking Chef" Ralf Jakumeit would go through fire for his absolute favorite!

PREMIUMCUT FILLET KNIFE NO 1
Micarta Handle.

Item #	Blade L"
181921	6 3/4



- The impressive design gets our hearts pumping.
- Red Diamond will take your breath away: The special manufacturing process creates one-of-a-kind handles, each one unique.
- Fire, meat and Red Diamond – what could be better?

PREMIUMCUT FILLET KNIFE NO 1
Red Diamond Handle.

Item #	Blade L"
181922	6 3/4



- One look alone is enough to heighten all your senses and get ready for cooking.
- Exotic fragrances and spices mingle – you are one with your knife.

PREMIUMCUT FILLET KNIFE NO 1
Spicy Orange Handle.

Item #	Blade L"
181923	6 3/4



- Tradition meets perfection.
- White cedar burl wood makes our Tree of Life handle a cut above.
- Thuja – also known as arborvitae or "tree of life" – has an extremely tough burl that makes using the knife an absolute pleasure.

PREMIUMCUT FILLET KNIFE NO 1
Thuja - Tree of Life Handle.

Item #	Blade L"
181924	6 3/4



MADE IN SPAIN

MEAT TENDERIZER PEHD
Blade 13 3/4" x 2 2/3".

Item #	Weight
181046	1 lb. 3 oz.



STAINLESS STEEL SAFETY APRON
For height 5 7/8 ft to 6 5/8 ft.

Item #	W"	H"
181048	21 2/3	33 1/2

GIESSER
MADE IN GERMANY**PREMIUMCUT - SET OF 3 KNIVES RED DIAMOND**

Red Diamond Handle. Set includes: Barbecue Knife No 1 (11 3/4" blade), Chefs No 1 Knife (7 3/4" blade) and Fillet Knife No 1 (6 3/4"). The impressive design gets our hearts pumping. Red Diamond will take your breath away: The special manufacturing process creates one-of-a-kind handles, each one unique.

Fire, meat and Red Diamond – what could be better?

Item #

181992

**PREMIUMCUT - SET OF 3 KNIVES SPICY ORANGE**

Spicy Orange Handle. Set includes: Barbecue Knife No 1 (11 3/4" blade), Chefs No 1 Knife (7 3/4" blade) and Fillet Knife No 1 (6 3/4"). One look alone is enough to heighten all your senses and get ready for cooking. Exotic fragrances and spices mingle – you are one with your knife.

Item #

181993

**PREMIUMCUT - SET OF 3 KNIVES THUJA - TREE OF LIFE**

Thuja - Tree of Life Handle. Set includes: Barbecue Knife No 1 (11 3/4" blade), Chefs No 1 Knife (7 3/4" blade) and Fillet Knife No 1 (6 3/4"). Tradition meets perfection. White cedar burl wood makes our Tree of Life handle a cut above. Thuja – also known as arborvitae or "tree of life" – has an extremely tough burl that makes using the knife an absolute pleasure. A handle of outstanding quality.

Item #

181994

**PREMIUMCUT - SET OF 3 KNIVES ROCKING CHEFS**

Micarta Handle. Set includes: Barbecue Knife No 1 (11 3/4" blade), Chefs No 1 Knife (7 3/4" blade) and Fillet Knife No 1 (6 3/4").

Rocking Chefs are tough guys with a soft core: Micarta handle, a natural material. Every handle is unique and makes you the real hero of the kitchen. "Rocking Chef" Ralf Jakumeit would go through fire for his absolute favorite!

Item #

181991

**BUTCHER'S SAW**

Can be dismantled. Tautness adjuster on the handle. Stainless steel blade.

Item #

100110

L"

17 3/4

W"

6

Replacement blades for butcher's saw.

Item #

100115

L"

17 3/4

W"

3/8

**HEAVY CLEAVER WITH HACCP**

Blade 7 3/4". Black.

Item #

182783

L of blade

9



SAFETY AND HYGIENE IN FOOD PROCESSING



GIESSER MESSER PURPLE ALLERGEN FREE KNIVES



PURPLE ALLERGEN FREE BONING KNIFE

Item #	Blade L"
182829	6



- The new color for the kitchen.
- High-quality handle without any additives that could be derived from tallow/lard.
- The color supports and complements your hygiene concept.
- Ideal for vegan, allergen free and halal gastronomy.



PURPLE ALLERGEN FREE SERRATED HAM KNIFE

Item #	Blade L"
182821	12 1/4



PURPLE ALLERGEN FREE PARING KNIFE

Item #	Blade L"
182804	4 1/4



PURPLE ALLERGEN FREE PARING KNIFE

Item #	Blade L"
182803	4



PURPLE ALLERGEN FREE CHEFS KNIFE

Item #	Blade L"
182812	7 3/4



PURPLE ALLERGEN FREE CHEFS KNIFE

Item #	Blade L"
182813	10 1/4





CHEF JET TILA
LOS ANGELES - USA

COOKWARE

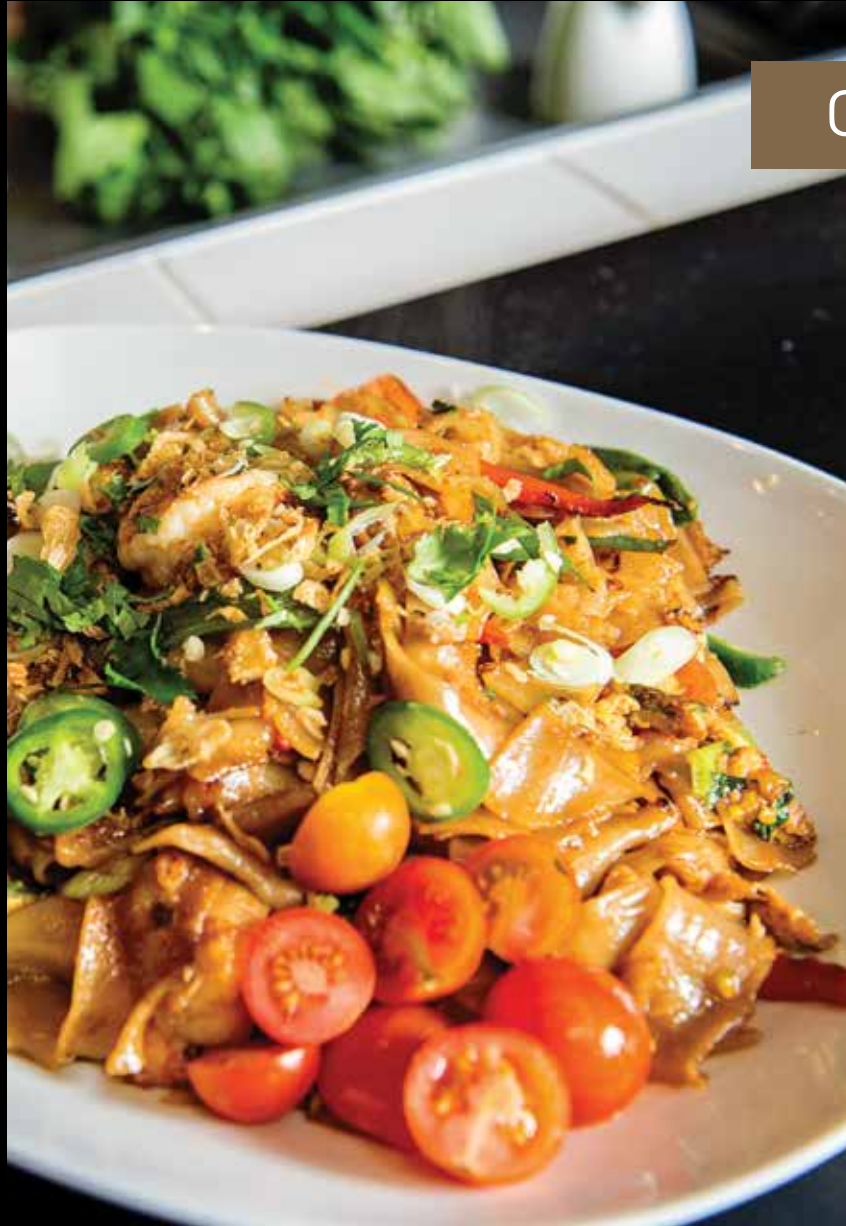

ELITE CERAMIC



With its extra-hard ceramic coating, without PTFE, this range for all heat sources, including induction, meets all normal kitchen requirements. It resists high temperatures up to 400°C. Can be used in the oven and is dishwasher safe.



ALL HEAT SOURCES INCLUDING INDUCTION.

SEE P. 181

COPPER



The premium range of copper pans for cooking. Interior in stainless steel for easy cleaning, no tinning required. The 2.5mm thickness guarantees even cooking and remarkable heat conduction properties for perfect flavor.



ALL HEAT SOURCES EXCEPT INDUCTION.

SEE P. 182

EXCELLENCE



The benchmark for demanding chefs. Thick stainless steel body. Sandwich base in stainless steel/aluminum/stainless steel. Patented cold-touch handles for ease of use.



10 YEAR WARRANTY

ALL HEAT SOURCES INCLUDING INDUCTION.

SEE P. 186

TRADITION



Premium quality pans for chefs. Thick stainless steel body with upper and lower reinforcements in mirror finish. Sandwich base in stainless steel/aluminium/stainless steel. Strong handles in stainless steel tubing, soldered without rivets.



ALL HEAT SOURCES INCLUDING INDUCTION.

SEE P. 189

NON STICK



Thick aluminum and multi-layer coating guarantee non-stick qualities and durability for this complete range of frying pans equipped with epoxy coated strip metal handles.



SEE EXCALIBUR FRY PAN & ELITE PRO FOR INDUCTION COMPATIBILITY.

SEE P. 190

BLACK STEEL



Natural mineral material which allows healthy cooking. Once seasoned (required), it will result in an even non-stick coating. It is ideal for searing meats, browning omelettes and grilling fish.



ALL HEAT SOURCES INCLUDING INDUCTION.

SEE P. 192



ELITE CERAMIC COOKWARE

Universal ceramic pans able to withstand high temperatures, with ultra-resistant ceramic coating.



Heat is quickly and evenly distributed.
Stainless steel handle.
Handle attached with covered rivets.
Handle loop for hanging.
Laquered exterior and covered edges
cleans easily.



ELITE CERAMIC TRADITIONAL WOK

Item #	Ø"	Capacity
687835	13 3/4	5 1/4 qts



ELITE CERAMIC CREPE PAN

Item #	Ø"	H"
666228	11	3/4



ELITE CERAMIC FRY PAN

Item #	Ø"	H"
665220	7 3/4	1 1/2
665224	9 1/2	1 1/2
665228	11	1 3/4
665232	12 1/2	2

BISTRO VITRO CERAMIC CLEANER

It cleans and removes traces of burnt residues on stove tops (halogen, radiant, induction). Leaves an invisible coat that facilitates maintenance.



Item #	Capacity
720358	8 1/2 oz.





COPPER COOKWARE

Made of high quality copper with stainless steel lining. The premium range of pans for cooking. Combining the optimum heat conductivity of copper with the easy clean properties of a stainless steel interior.



- 1 Smooth copper exterior.
- 2 Straight overturn non-drip edge.
- 3 Stainless steel interior: easy to clean.
- 4 Cast iron handle.



CHEF'S TIP TO CHOOSE THE RIGHT LID:

Match 2 last digits of item # of the lid with last 2 digits of pan or pot. Example: 374024 BRASIER - matching lid 365024.

BOURGEAT COPPER SAUCE PAN

Item #	Ø"	H"	Qts	Wt
360012	4 3/4	2 3/4	7/8	2 lbs. 9 oz.
360014	5 1/2	3	1 1/4	3 lbs. 9 oz.
360016	6 1/4	3 1/2	1 14/16	4 lbs. 12 oz.
360018	7 1/8	3 3/4	2 5/8	5 lbs. 9 oz.
360020	7 7/8	4 1/8	3 3/4	6 lbs. 9 oz.
360024	9 1/2	4 3/4	6 3/8	8 lbs. 10 oz.

BOURGEAT COPPER LID

Item #	Ø"	Wt
365012	4 3/4	7 oz.
365014	5 1/2	9 oz.
365016	6 1/4	11 oz.
365018	7 1/8	14 oz.
365020	7 7/8	1 lb. 1oz.
365024	9 1/2	1 lb. 8 oz.
365028	11	1 lb. 10 oz.



BOURGEAT COPPER COOKWARE SET

Item #	Wt lbs.
915901	38

SET OF 8 ITEMS INCLUDE:

Item #	Ø "	Qts	Description
367024	9 1/2	5-3/4	copper casserole
365024	9 1/2		copper lid for casserole
360018	7 1/8	2-5/8	copper sauce pan
365018	7 1/8		copper lid for sauce pan
373024	9 1/2	2-3/4	copper flared saute pan
365024	9 1/2		copper lid for flared saute pan
374028	11	5-1/4	copper heavy saute pan
365028	11		copper lid for heavy saute pan



BOURGEAT COPPER CASSEROLE WITHOUT LID

Item #	Ø "	H "	Qts	Wt
367020	7 7/8	4 1/8	3 1/2	5 lbs. 7 oz.
367024	9 1/2	4 3/4	5 3/4	7 lbs. 15 oz.
367028	11	5 1/8	8 1/2	10 lbs. 3 oz.



BOURGEAT COPPER BRASIER WITHOUT LID

Item #	Ø "	H "	Qts	Wt
374024	9 1/2	2 3/4	3 1/3	6 lbs. 10 oz.
374028	11	3 1/8	5 1/4	8 lbs. 12 oz.





LEARN MORE ABOUT THIS PRODUCT IN OUR CHEF LIFESTYLE BLOG.



BOURGEAT COPPER SAUTE PAN WITHOUT LID

Item #	Ø"	H"	Qts	Wt
372016	6 1/4	2	1	3 lbs. 14 oz.
372020	7 7/8	2 3/8	2	5 lbs. 3 oz.
372024	9 3/8	2 13/16	3 5/16	6 lbs. 12 oz.
372028	11	3 1/8	5 1/4	10 lbs. 1 oz.



BOURGEAT COPPER FLARED SAUTE PAN WITHOUT LID

Item #	Ø"	H"	Qts	Wt
373016	6 1/4	2 3/8	3/4	3 lbs. 8 oz.
373020	7 7/8	2 13/16	1 5/8	4 lbs. 11 oz.
373024	9 1/2	3 1/8	2-3/4	6 lbs. 15 oz.
373028	11	3 1/2	4	8 lbs. 8 oz.



BOURGEAT COPPER FRYING PAN

No Lid available.

Item #	Ø"	H"	Qts	Wt
369024	9 1/2	2	1 5/8	5 lbs. 4 oz.
369028	11	2 1/4	2 3/8	6 lbs. 9 oz.



COPPER MINI-COOKING POT

Stainless steel inner. Polished brass handles.

Item #	Ø "	H "	Qts "	Wt oz.
034101	3 1/2	1 3/4	0 19/64	9 1/2
034103	4 3/4	2 1/3	0 47/64	23 2/3



EXTRA HEAVY JAM PAN SOLID COPPER

With 2 bronze handles.

Item #	Ø "	H "	Qts "	Wt lbs.
304042	16 1/2	7 1/8	16 3/4	8 3/8



BISTRO COPPER CLEANING PASTE

Item #	Description	Wt
720311	jar of 5 fl. oz.	9 oz.
720312	jar of 35 fl. oz.	3 lbs. 1 oz.



BOURGEAT MINI COPPER SAUCE PAN

For flambé or individual tableware. With no-drip edge.

Item #	Ø "	H "	Capacity	Wt oz.
351009	3 1/2	1 3/4	9 1/2 oz.	9
351209	3 1/2			4 (lid)



BOURGEAT COPPER SUGAR PAN

Copper body, stainless steel "cold touch" handle.

Item #	Ø "	H "	Capacity	Wt
305016	6 1/4	3 1/2	1 3/4	2 lbs. 12 oz.
305020	7 7/8	4 3/8	3 1/2	4 lbs. 2 oz.



BOURGEAT COPPER JAM PAN

Solid copper bowl, (no tin lining) with rolled and reinforced edge. With riveted brass handles.

Item #	Ø "	H "	Capacity	Wt
303036	15	5	10 qts	10 qts, 3 lbs.

REFRACTOMETER

High definition. For checking sugar content expressed in % Brix. Reader Ø 40 mm (1 1/2"). Reference temperature 20°C (68°F), sample temperature 40°C (104°F) maximum. Comes in a protective box.



Refractometer 0 to 50 %. Precision ± 1 % for sorbets, ice creams, fruit juice concentrates, etc.

Item #	L "	Wt oz.
250122	5 7/8	5

Refractometer 58 à 90 %. Precision ± 0,5 % for jelly, jam, syrups.

Item #	L "	Wt oz.
250124	5 7/8	5





10 YEAR WARRANTY



MADE IN FRANCE

EXCELLENCE COOKWARE



LEARN MORE ABOUT THIS PRODUCT IN OUR CHEF LIFESTYLE BLOG.



SEE INSTRUCTIONS P. 9

Design that combines cooking performance with ergonomics. **COOKING:** Optimized cooking by uniform heat conduction in skirt and base. May be used on any available heat source. **HYGIENE:** Handles are perfectly watertight (no risk of bacteria development). The angle at the base and area around the handle are designed for easy cleaning.



- 1 Special stainless steel body.
- 2 Sandwich aluminum base bottom with shape memory.
- 3 Base covered with metallic stainless steel disk for induction.
- 4 Reinforced edge.
- 5 Handles are insulated stainless steel tube and "STAY COOL" to prevent heat diffusing.

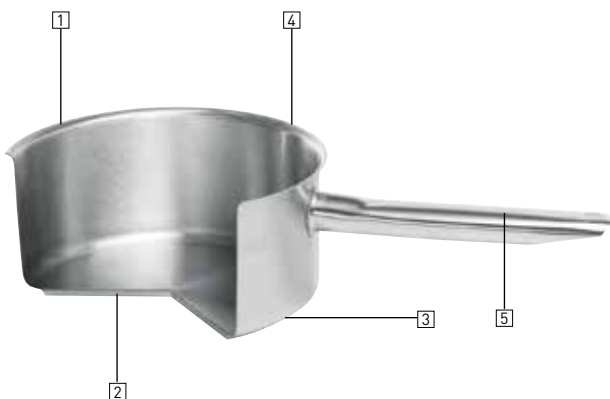

EXCELLENCE CASSEROLE WITHOUT LID

Item #	Ø "	H "	Qts	Wt
693024	9 1/2	4 3/4	5 3/4	4 lbs. 3 oz.
693028	11	5 1/2	9	5 lbs. 14 oz.
693032	12 5/8	6 3/8	13 1/2	7 lbs. 8 oz.
693036	14 1/8	7	19 3/8	5 lbs. 3 oz.
693040	15 3/4	8	26 1/2	5 lbs. 3 oz.

NON-INDUCTION

693045	17 3/4	9	38	5 lbs. 3 oz.
693050	19 3/4	9 7/8	52	5 lbs. 3 oz.

BISTRO STAINLESS STEEL CLEANING CREAM



Cleans and polishes stainless steel surfaces, regardless of the finish: shining, satin or brushed. It may be used for maintenance of stainless steel furniture in professional kitchens.

Item #	Capacity
720360	8 1/2 oz.



EXCELLENCE STOCKPOT WITHOUT LID

Item #	Ø"	H"	Qts	Wt
694024	9 1/2	9 1/2	11 1/2	4 lbs. 8 oz.
694028	11	11	18	6 lbs. 10 oz.
694032	12 1/2	12 1/2	26	8 lbs. 7 oz.
694036	14 1/8	14 1/8	38	13 lbs. 2 oz.
694040	15 3/4	15 3/4	53	16 lbs. 3oz.

NON-INDUCTION

694045	17 3/4	17 3/4	76	27 lbs. 8 oz.
694050	19 5/8	19 5/8	104	34 lbs. 7 oz.



EXCELLENCE STOCKPOT WITHOUT LID

Item #	Ø"	H"	Qts	Wt
690024	9 1/2	6 3/8	7 1/2	4 lbs. 8 oz.
690028	11	7 3/8	11 1/2	6 lbs. 10 oz.
690032	12 1/2	8 1/2	19	8 lbs. 6 oz.
690036	14 1/8	9 1/2	25 1/2	13 lbs. 1 oz.
690040	15 3/4	10 1/2	36	16 lbs.

NON-INDUCTION

690045	17 3/4	11 1/2	38	25 lbs. 4 oz.
690050	19 3/4	12 1/2	52	29 lbs. 2 oz.



EXCELLENCE STEAMER

Item #	Ø/H/Qts	Wt
698024	9 1/2" to fit a 9 1/2" pot	4 lbs. 8 oz.
698028	11" to fit a 11" pot	6 lbs. 10 oz.



CHEF'S TIP TO CHOOSE THE RIGHT POT:
Match last 2 digits of item # of the steamer
with last 2 digits of pot.
Ex 698024 steamer - matching stockpot 690024.



EXCELLENCE BRASIER WITHOUT LID

Item #	Ø"	H"	Qts	Wt
697028	11	3 1/2	5 3/4	5 lbs. 1 oz.
697032	12 1/2	4	8 1/2	6 lbs. 5 oz.
697036	14 1/8	4 3/4	12 3/4	9 lbs. 8 oz.
697040	15 3/4	5	17	11 lbs. 6 oz.

NON-INDUCTION

697045	17 3/4	5 7/8	24	19 lbs. 7 oz.
697050	19 3/4	6 1/2	34	24 lbs. 2 oz.





- Special stainless steel body compatible with all cooktops.
- Aluminum "sandwich bottom" retains heat to insure perfect cooking distribution.
- Magnetic stainless steel base specially for induction cooking.
- Strengthened spill catching rim.
- Comfortable welded stainless steel handle.



EXCELLENCE FRY PAN

Item #	Ø"	H"	Qts	Wt
675020	7 7/8	1 3/8	7/8	1 lb. 14 oz.
675024	9 1/2	1 1/2	1 1/2	2 lbs. 8 oz.
675028	11	1 3/4	2 5/16	4 lbs. 4 oz.



EXCELLENCE SAUTE PAN WITHOUT LID

Item #	Ø"	H"	Qts	Wt
696020	7 7/8	2 3/4	1 1/2	2 lbs. 2 oz.
696024	9 1/2	3 1/8	2 3/4	3 lbs. 14 oz.
696028	11	3 1/2	4	5 lbs. 5 oz.



EXCELLENCE STOCKPOT WITH TAP WITHOUT LID

Item #	Ø"	H"	Qts	Wt
694324	9 1/2	9 1/2	11 1/2	6 lbs. 5 oz.
694328	11	11	18	8 lbs. 9 oz.
694332	12 1/2	12 1/2	26	10 lbs. 9 oz.
694336	14 1/8	14 1/8	38	15 lbs. 5 oz.
694340	15 3/4	15 3/4	53	19 lbs. 2 oz.



TRIANGLE PASTA COOKER/STRAINER

Made of Stainless Steel. To be used with 14 1/8" diam. pot.

Item #	H"	Qts
713504	7	3



EXCELLENCE SAUCE PAN WITHOUT LID

Item #	Ø"	H"	Qts	Wt
691012	4 3/4	2 1/2	1/2	1 lb. 3 oz.
691014	5 1/2	2 3/4	1	1 lb. 5 oz.
691016	6 1/4	3	1 3/4	1 lb. 10 oz.
691018	7 1/8	3 1/2	2 3/8	2 lbs.
691020	7 7/8	3 7/8	4	2 lbs. 6 oz.
691024	9 1/2	4 3/4	4 3/4	4 lbs. 7 oz.
691028	11	5 1/2	9	5 lbs. 10 oz.



SEE SILICONE BRUSH P. 126



LID RACK

Stainless steel, rack for 10 lids. From 9 1/2" to 19 3/4" Ø.

Item #	L"	W"	Wt lbs.
015210	15 3/8	12	7



TRADITION COOKWARE



SEE INSTRUCTIONS P. 9

Sandwich base in stainless steel/aluminum/ stainless steel.
 Base covered with a magnetic stainless steel disc specifically for induction hobs.
 Reinforced non-drip rim.
 Strong stainless steel welded handles soldered without rivet. Handles are insulated stainless steel tube and "STAY COOL" to prevent heat diffusing.
 Extra-thick reinforced upper and lower edges of the pan body.

Premium stainless steel body with upper & lower reinforcements in polished mirror finish.



TRADITION FRY PAN

Item #	Ø "	H "	Qts	Wt
685020	7 7/8	2 3/4	1 1/2	2 lbs. 4 oz.
685024	9 1/2	3 1/8	2 3/4	3 lbs. 5 oz.
685028	11	3 1/2	4	4 lbs. 4 oz.
685032	12 1/2	2	3 3/4	5 lbs. 5 oz.



TRADITION FLARED SAUTE PAN WITHOUT LID

Item #	Ø "	H "	Qts	Wt
686520	7 7/8	2 3/4	1 1/2	2 lbs. 4 oz.
686524	9 1/2	3 1/8	2 3/4	3 lbs. 5 oz.
686528	11	3 1/2	4	4 lbs. 4 oz.



CHEF'S TIP TO CHOOSE THE RIGHT LID: Match 2 last digits of item # of the lid with last 2 digits of pan or pot. Example: 685020 FRY PAN "Tradition Plus" - MATCHING LID 692020.

TRADITION AND EXCELLENCE LIDS

Item #	Ø "	Wt	Item #	Ø "	Wt
692014	5 1/2	6	692032	12 5/8	1 lb. 7 oz.
692016	6 5/16	8	692036	14 1/4	1 lb. 8 oz.
692018	7 1/8	9	692040	15 3/4	2 lbs. 4 oz.
692020	7 7/8	11	692045	17 3/4	3 lbs. 9 oz.
692024	9 1/2	15	692050	19 3/4	5 lbs. 1 oz.
692028	11	1 lb, 5 oz.			



687830



686730

TRADITION CERAMIC WOK

Item #	Ø "	H "	Qts	Wt
687830	11 7/8	4 21/64	4 1/4	32 oz.

TRADITION WOK

Item #	Ø "	H "	Qts	Wt
686730	12	4	4	2 lbs. 1oz.





CLASS CHEF+ NON-STICK COOKWARE



SEE INSTRUCTIONS P. 9



- 1 PFOA-FREE guaranteed coatings.
- 2 Easy to clean grey lacquer exterior.
- 3 Wide stainless steel handle attached with 3 rivets (except blini pan which has 2 rivets).
- 4 Rayonnated base.

Frying pans in extra strong aluminum with 4-layer non-stick coating.



ROUND FRYING PAN

Item #	Ø"	H"	Qts	Wt
906020	7 7/8	1 1/2	1	1 lb. 3 oz.
906024	9 3/8	1 1/2	1 3/8	1 lb. 11 oz.
906028	11	1 3/4	2 1/8	2 lbs. 3 oz.
906032	12 5/8	2	3 1/4	2 lbs. 15 oz.
906036	14 1/4	2	4 1/4	4 lbs. 6 oz.
906040	15 3/4	2	5 5/16	5 lbs. 4 oz.

CREPE PAN

Item #	Ø"	H"	Qts	Wt
907525	9 13/16	3/4	13/16	1 lb. 2 oz.
907528	11	3/4	1 1/4	1 lb. 6 oz.



CHINESE WOK

Item #	Ø"	H"	Qts	Wt
909528	11	3 1/8	1/8	1 lb, 15 oz.



EXCALIBUR FRY PAN

Non-stick interior reinforced with stainless steel. Comfortable, stay-cool stainless steel handle. Suitable for all heat sources, including induction.



Item #	Ø"	H"	Qts	Wt
669420	7 7/8	1 1/2	7/8	1 lb. 13 oz.
669424	9 1/2	1 1/2	1 1/2	2 lbs. 8 oz.
669428	11	1 3/4	2 5/16	4 lbs. 1 oz.
669432	12 1/2	2	3 3/8	5 lbs. 7 oz.



COOKWARE

NON-STICK



OVAL FRYING PAN OR FISH PAN

Item #	L"	W"	Thk
908036	14 1/5	9 5/6	1/6
908040	15 13/4	11	1/6



BLINI PAN

Item #	L"	W"	Thk
907012	4 3/4	1	1/12



RECTANGULAR FISH FRYING PAN

Item #	Ø"	H"	Qts	Wt
908538	15	1 1/2	3 1/4	3 lbs. 7 oz.



ROAST PAN WITH BUILT IN HANDLE

Item #	Ø"	H"	Qts	Wt
664050	19 3/4	3 1/2	16 7/8	7 lbs. 7 oz.



ELITE PRO SPECIAL ALUMINUM FRY PAN WITH INDUCTION BOTTOM

- 1 Thick, heat diffusing base with special induction stainless steel bottom plate.
- 2 Coated rivets inside.
- 3 4-layer non-stick coating with anti-scratch protective undercoat.
- 4 Extra thick 5mm aluminum construction.
- 5 Hanging loop in handle.
- 6 Aluminum "cool touch" handle.

Item #	Ø"	H"	Wt
668524	9 1/2	2	2 lbs. 10 oz.
668528	11	2	3 lbs. 7 oz.
668532	12 5/8	2	4 lbs. 9 oz.





CAN BE "SEASONED" FOR NON STICK USE AND PROLONGED LIFE. SEE INSTRUCTIONS P. 9

BLACK STEEL COOKWARE



Our incredible black steel fry pans are amazingly strong and made to last. When sufficiently heated it causes a rapid mark well known to cooks and thereby ensures a good coloring of the products without overcooking them.

- 1 Black Steel distributes heat excellently.
- 2 High quality, extra strong steel strip handle.
- 3 Heavy duty construction.

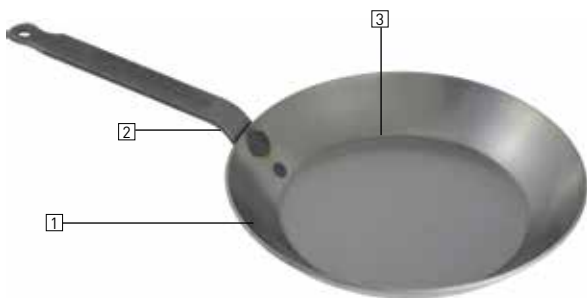

BLACK STEEL ROUND FRYING PAN

Item #	Ø "	H "	Wt
062001	8 1/2	1 1/2	2 lbs. 12 oz.
062002	9 1/2	1 3/4	3 lbs. 1 oz.
062003	10	2	3 lbs. 11 oz.
062004	11	2	4 lbs. 2 oz.
062005	11 3/4	2 1/8	4 lbs. 11 oz.
062006	12 5/8	2 3/8	5 lbs. 3 oz.
062007	14	2 1/2	6 lbs. 14 oz.
062008	15 3/4	2 3/4	8 lbs. 2 oz.
062009	17 3/4	3	9 lbs. 8 oz.



BLINI PAN

Item #	Ø "	H "	Wt lb.
062040	4 3/4	7/8	1



ROUND CREPE PAN

Item #	Ø "	Wt
062031	7	1 lb. 4 oz.
062032	7 7/8	1 lb. 7 oz.
062033	8 5/8	1 lb. 12 oz.
062034	9 1/2	2 lb.



LEARN MORE ABOUT THIS PRODUCT
IN OUR CHEF LIFESTYLE BLOG.

LE CHASSEUR ENAMELED CAST IRON



From kitchen to table! Delivered with 2 knobs: 1 stainless steel and 1 black Bakelite.



- Even heat distribution and retention.
- Suitable for all hobs including induction.
- Enameled base will not scratch cooktops.
- Cast iron cookware retains nutritional content in foods!



CAST IRON RECTANGULAR TERRINE

Item #		L"	W"	H"	Qts
071070	black	11	6	4 3/4	1 1/4
071072	black	12 1/2	4 1/3	4 3/4	1 3/8
071074	red	11	6	4 3/4	1 1/4
071076	red	12 1/2	4 1/3	4 3/4	1 3/8



CAST IRON ROUND CASSEROLE POT WITH LID
Mini Black.

Item #	Ø"	H"	Qts
071098	4	3 1/2	1/4



CAST IRON CREPE PAN
Black with beechwood spatula and spreader.

Item #	Ø"
071122	11 3/4



REVERSIBLE GRIDDLE
Black cast iron with two handles, suitable for gas stoves. Slick one side and grooved on the other.

Item #	L"	W"	H"	Wt
071058	19 2/3	13 3/4	1 1/8	11 lbs. 3 oz.



LE CHASSEUR FONDUE POT
Includes base, fork grooved splatter guard, burner and six assorted color fondue forks.

Item #	Ø"	H"	Capacity
070971	9	8 1/4	1



FLAT CAST IRON COOKING PLATTER
Cast iron, wood base. Includes a removable gripping handle.

Item #	Ø"
079611	11 7/8





ROAST PAN
Made of 18/10 Stainless steel.



Item #	L"	W"	H"	Wt
713540	17	13 3/4	3 1/2	9 qts
713550	20 7/8	17	3 1/2	15 7/8 qts
713560	24 3/4	20 1/8	4 7/8	25 7/8 qts



PRESSURE COOKER

Pressure cooker is made of 18/10 stainless steel. It features a safety valve and heat diffusing sandwich bottom. It can be used on any cooktops types, including induction. Dishwasher safe.

Item #	Capacity
013204	8 1/2 qts with steamer basket
013206	12 2/3 qts without steamer basket
013227	steamer basket (spare part)



PRESSURE COOKER

Plastic handles, fast close lid and suitable for all cooktops including induction. Made of 18/10 stainless steel with triple layer base of steel - copper - steel.

Item #	Capacity
013203	8 liters / 8 1/2 qts with steamer basket
013320	13 liters / 14 qts without steamer basket

SPARE PARTS

Item #	Description	Wt
013230	steamer basket	2 oz.
013231	regulator	15 7/8 qts



FISH POACHER

Made of stainless steel. Complete with grid and lid.

Item #	Ø"	H"	Qts	Wt
073597	23 3/4	6 1/4	4 3/4	5 lbs. 11 oz.



BAIN-MARIE WITHOUT LID

Made of 18/10 stainless steel.

Item #	Ø"	H"	Qts	Wt
702212	4 3/4	4 3/4	1 1/2	14 oz.
702214	5 1/2	5 1/2	2 1/4	1 lb. 3 oz.
702216	6 1/4	6 1/4	3 1/2	1 lb. 7 oz.
702218	7 1/8	7 1/8	5	1 lb. 9 oz.



STAINLESS STEEL PELLA PAN

Pan with handles suitable for all cooktops including induction. Sandwich bottom: stainless steel - aluminum - stainless steel provides uniform heating.

Item #	Ø"	H"
070988	11	1 1/2
070990	12 1/2	1 1/2
070992	14 1/8	1 1/2



KITCHEN UTENSILS HANGING RAIL

One piece hanging rail suitable for hook or hole hanging utensils. Made of stainless steel.

Item #	L"
719110	39 3/8



SPICE INFUSER

For infusing herbs and spices.

- 4 notches to allow for different volumes.
- Both parts of the stainless steel infuser are kept together thanks to a silicone thread that links them.
- This silicone thread has a hook on the end, allowing the infuser to be suspended from the handle of the cooking pot.

Item #	Ø"	L"
071351	1 7/8	4 1/3 to 5 1/8



STAINLESS TRAY + GRID

Small pan, practical for cooking, for draining cooked meat and reserving small quantities of ingredients (without grid).

Item #	L"	W"	H"
714021	8 1/16	5 7/8	1 1/8
714022	9 1/4	7 1/2	1 3/8



BLACK STEEL PELLA PAN

Curved sides, two handles.

Item #	Ø"	H"	Wt
062051	14 1/8	1 5/8	6 lbs. 2 oz.
062052	15 3/4	2 1/16	7 lbs. 6 oz.
062053	17 3/4	2 1/4	9 lbs. 2 oz.



POLISHED STEEL PELLA PAN

Item #	Ø"
070522	7 7/8
070528	11
071038	14 1/8
071041	15 3/4
071050	27 1/2
071052	35 1/2



FLAME TAMER

Tinned steel with folding wire handle, for protecting porcelain, glass and fire clay containers from flame.

Item #	Ø"
639001	8 1/4





WALL MOUNTED UTENSILS SHELF

Made of stainless steel. Holds up to 100 lbs.

Item #	L"	Depth	H"	Th"
845608	31 1/2	11 3/4	15 3/4	1/16
845612	47 1/4	11 3/4	15 3/4	1/16



ADJUSTABLE WALL SHELF

Adjustable in 3 dimensions: height, width and depth.

Adapts to all walls by offering potential gaps for electrical cables, pipes, furniture, etc.

Includes 2 shelves and 2 rails.

Wall mounting should be carried out using the appropriate wall plugs for the related wall and preferably stainless steel screws.

Hardware not included.

1000 mm-tall (39 1/3") rack rails with 107mm (4 1/4") thread. All stainless steel. Holds up to 100 lbs.

Item #	L"	Depth
845618	31 1/2	18 1/2
845622	47 1/4	18 1/2



UTENSILS WALL RACK - PANEL ONLY

Effective utensil storage and tidy.

Adjustable hook system.

Panel does not include hooks. Includes stainless steel screws and wall plugs.

Perforated stainless steel panel (Ø 6mm (1/4") perforations), centre distance 60mm (2 1/3").

Item #	Size	L"	H"
845760	Overall height 29 3/4	23 3/4	27 1/2

HOOKS FOR UTENSILS WALL RACK

Stainless steel hooks. Pack of 3.

Item #	L"
845762	11 7/8
845763	7 7/8



WALL MOUNTED SHELF FOR BOTTLES

Inner storage dimensions : 640 x 95 mm (25 1/5" x 3 3/4").

Stainless steel hardware included for wall mounting.

Item #	L"	Depth	H"
846007	25 5/8	4 1/8	4 1/3



HANDY FRESH INGREDIENTS

5 CONTAINERS CONDIBOX

Perfect for keeping service condiments cold and fresh separately for hours.



- Use with frozen cooling blocks, placed at the bottom of the container.
- Keeps herbs fresh throughout serving period.
- Keeps ingredients cool for several hours for use in preparing sandwiches, mixed salads, iced desserts.
- Delivered with 5 stainless steel GN 1/9 containers and 2 cooling blocks.



CONDIBOX STAINLESS STEEL

Item #	L"	W"	H"	Wt lbs.
511510	23	8	5 1/2	17

SPARE PARTS

Item #	Description	Wt
511512	Eutectic Plate	
747010	Stainless Steel 1/9 GN Pan	6 oz.



CONDIBOX CRYSTAL

Item #	L"	W"	H"
511508	23	8	5 1/2



- No electricity required.
- Reduced space requirements.
- Modular (Gastronorm containers).
- Two versions.



"JAPANESE MINI CONTAINERS" STAINLESS STEEL

Handy little kitchen containers for storing herbs and condiments, spices and small preparations. Stackable when the containers are empty.

The set includes four 714001 containers inside a large container with lid.

Item #	LID	L"	W"	H"	Cap
714001	714011	4	2 2/3	2 1/3	1/3 qts.
714002	714012	5 1/3	4 1/3	2 1/3	2/3 qts.
714003	714013	6 1/3	4 1/3	2 2/3	1 qts.
714000	Five-piece set	11	4 2/3	2 2/3	4 1/3 qts.



- Hemispheric bowls must be used with supporting base.
- Slanted supporting base makes it easy to view and identify contents.
- Plexiglass lid keeps spices/content fresh.
- 6 bowl version has rear compartment for 4 pouring bottles.



SPICES ROLL'BOX

Stainless steel, ideal for keeping all spices in a single container.



Item #	L"	W"	H"	Wt	Bowl cap
017084	20	5 1/4	4 1/4	4 lbs. 9 oz.	1 pint, 4 bowls
017082	15	14	5 1/2	3 lbs.	1 pint, 6 bowls





J.B. Laverne-Morazzani



CHEF JEAN-BAPTISTE LAVERNE-MORAZZANI
VERSAILLES - FRANCE

TABLE TOP





BLACK PORCELAIN made by REVOL only for Matfer Bourgeat.

BLACK PORCELAIN

Bowl Ø 163 mm (6 3/8"). Sold by two units.

Item #	L"	W"	H"
050061	13	8 2/3	1 1/6



TRANSPARENT SAN PLATE COVER

Hole Ø 40 mm (1 5/8").

Item #	Ø"	H"
050063	6 3/4	5 1/2



LID

Cork. sold by two units.



Item #	Ø"
050065	1 5/8

FRENCH FRIES BASKET

Stainless steel. Sold by 6 units (sold without paper).

Item #	L"	W"	H"
051136	4	3 1/3	3 1/3





- Non-porous, easy to clean, can be sterilized.
- Long-lasting - Non-deformable: will not deteriorate or rust over time.
- Perfect for non-stick coated pans: will not scratch.
- Super Heat Resistant: up to 430° F.
- Dishwasher Safe.

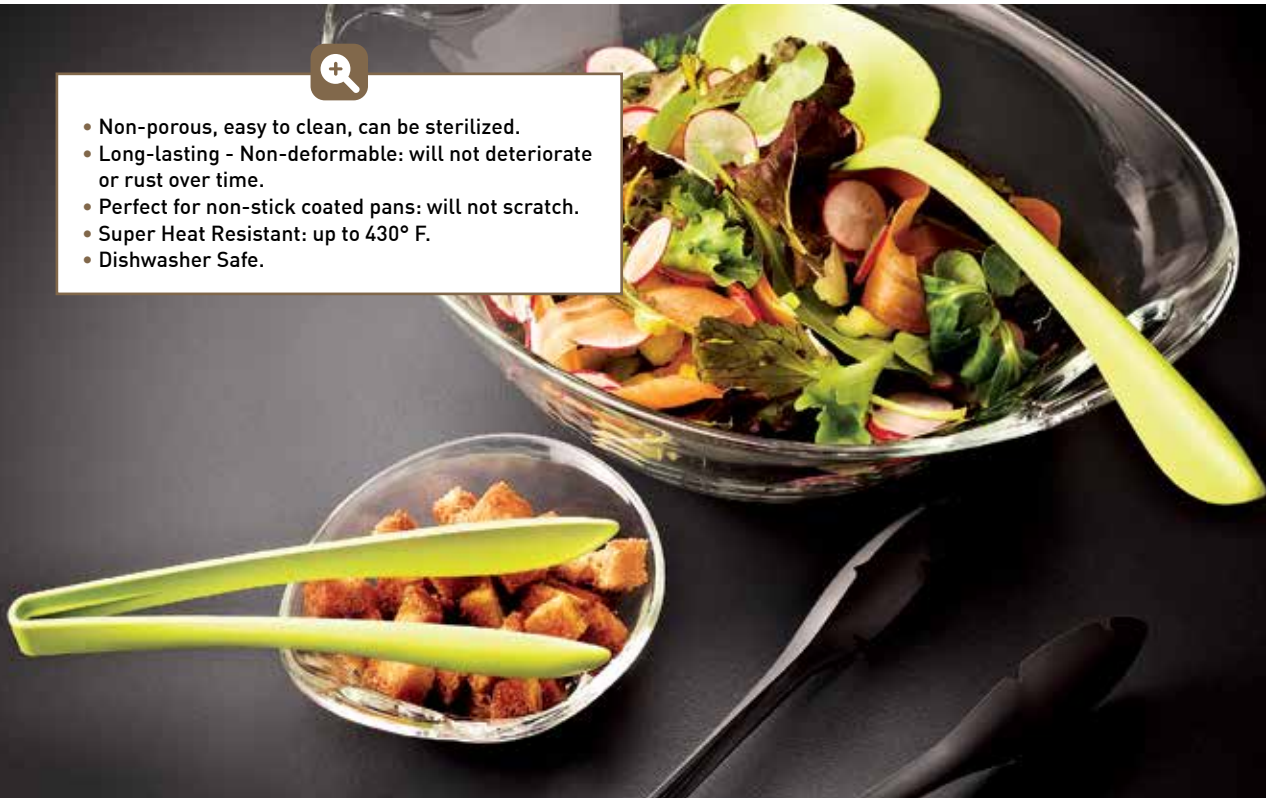

EXOGLASS® CURVE SERVING UTENSILS

Designed for buffet service: modern shape and comfortable grip during use. Will meet your high standards for sanitary hygiene in food contact environments.



LEARN MORE ABOUT THIS PRODUCT IN OUR CHEF LIFESTYLE BLOG.



PLAIN SERVING SPOON

Item #	L"	Color
650198	11 7/8	grey
650190	11 7/8	lime green



PERFORATED SERVING SPOON

Item #	L"	Color
650200	11 7/8	grey
650192	11 7/8	lime green



CAFETERIA TONGS

Item #	L"	Color
650202	9 7/8	grey
650194	9 7/8	lime green



TOPPING TONGS

Item #	L"	Color
650204	6 3/4	grey
650196	6 3/4	lime green



**PETIT PAN**

Made of porcelain. Pack of 6.

Item #	Ø"	L"	Capacity
051354	2 1/2	3 3/4	2 oz.

**PETIT COMMA**

Made of porcelain. Pack of 6.

Item #	L"	W"
051359	3 1/8	2 1/2

**PETIT DISH**

Round. Porcelain hotel ware. Stackable. Pack of 12.

Item #	Ø"	H"	Capacity
051165	2 2/3	1 1/6	1 7/8 oz.

**PETIT DROP**

White porcelain. Pack of 12.

Item #	L"	W"
050044	4 1/3	2 1/2

**PETIT EGG DISH**

Made of porcelain. Pack of 12.

Item #	L"	W"	Capacity
051357	2 3/4	2 1/3	2 1/4 oz.

**PETIT BOWL EVAZ**

Porcelain hotel ware. Pack of 12.

Item #	Ø"	H"	Capacity
970058	4	1 1/2	3 1/3 oz.

**PETIT 3 DISHES**

Porcelain hotel ware. Stackable. Pack of 6.

Item #	L"	W"	Capacity
050464	9	3	1 1/6



PETIT APPETIZER

Pyroblan porcelain hotel ware. Pack of 10.

Item #	Ø"	H"	Capacity
052300	2	1 7/8	2 oz.



PETIT DISH

Made of porcelain. Pack of 12.

Item #	L"	W"	H"	Capacity
051132	3 1/8	3 1/8	1 1/8	3 oz.



PETIT DISH

White porcelain. Pack of 12.

Item #	L"	W"	H"
050468	3	3	1 1/3



PETIT DISH

Made of porcelain. Pack of 6.

Item #	L"	W"
051356	3 1/8	2 1/8



PETIT CUBE

Porcelain hotel ware. Pack of 6.

Item #	L"	W"	H"	Capacity
466769	2 3/4	2 3/4	2 1/2	5 3/8 oz.



PETIT OVAL BOX WITH LID

Porcelain. Present a starter or side dish in an original way. Pack of 6.

Item #	L"	W"	H"	Capacity
052021	5 1/8	3 1/3	1 3/4	5 3/4 oz.



PETIT BOWL LUDICO

Extra resistant porcelain hotel ware. Mini and multi-purpose. Pack of 6.

Item #	Ø"	H"	Capacity
552730	3 3/4	2 1/3	15 oz.



PETIT RECTANGULAR BOX WITH LID

Porcelain. Present a starter or side dish in an original way. Pack of 6.

Item #	L"	W"	H"	Capacity
052023	5 1/8	3 1/3	1 1/2	6 oz.





ESCARGOT TONGS

Heavy duty stainless steel. Hinged spring mechanism holds snail securely in place. Pack of 12.



Item #	L"	Wt oz.
062160	6 3/8	2



ESCARGOT FORK

2 prong fork. Made of stainless steel. Pack of 12.

Item #	L"	Wt oz.
062150	5 3/8	1



LE CHASSEUR FONDUE POT

Includes base, fork grooved splatter guard, burner and six assorted color fondue forks.

Item #	Ø"	H"	Capacity
070971	9	8 1/4	1 qt



ESCARGOT PLATE 6 HOLES

Enamelled porcelain. Heat resistant up to 482°F. Pack of 6.

Item #		Ø"	H"
552104	6 holes	4 3/4	1 1/3
552106	12 holes	7 1/8	1 1/4



INDIVIDUAL ESCARGOT DISH

Made of earthenware. Pack of 48.

Item #	Ø"	H"
552102	1 1/2	1 1/5



ESCARGOT PLATE

Made of 18/8 stainless steel. Pack of 5.

Item #		Ø"	Wt oz.
613281	12 escargots	7 7/8	4
062075	6 escargots	4 3/4	3



FONDUE FORKS

Black plastic handle. Pack of 12.

Item #	L"
061715	11 7/8



MINI CAST IRON ROUND CASSEROLE POT WITH LID

Item #		Ø"	H"	Qts
071098	mini black	4	3 1/2	1/4

**BLINI PAN**

Item #	Ø"	H"	Wt lb.
062040	4 3/4	7/8	1

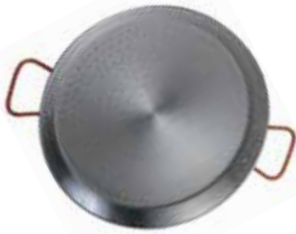

MADE IN SPAIN

POLISHED STEEL PAELLA PAN

Item #	Ø"
070522	individual serving
070528	11
071038	14 1/8
071041	15 3/4
071050	27 1/2
071052	35 1/2

**MATFER CRÈME BRULÉE DISH**

Glazed earthenware. Pack of 8.

Item #	Ø"	H"
052278	4 3/4	1 1/4
052280	5 1/2	1 1/4

**EARTHENWARE CASSOULET DISH**

Glazed earthenware. Stackable.

Item #	Ø"	H"	Capacity oz.	Wt oz.
059925	6 1/4	2 1/8	23	4

**BOURGEAT MINI COPPER SAUCE PAN**

For flambé or individual tableware. With no-drip pour edge.

Item #	Ø"	H"	Capacity oz.	Wt oz.
351009	3 1/2	1 3/4	9 1/2	9
351209	3 1/2			4 lid

**FLAT CAST IRON SIZZLE PLATTER**

Cast iron, wood base. Includes a removable gripping handle.

Item #	Ø"
079611	11 7/8

**EARTHENWARE DISH**

Glazed earthenware. Stackable.

Item #	Ø"	H"	Capacity	Wt oz.
052284	6 2/3	2 1/4	23	4

**EARTHENWARE ROUND BOWL**

Pack of 6.

Item #	Ø"	H"	Capacity oz.
552167	n°5	5 1/2	2





MINI APPETIZER/JAM JAR

Made of glass for serving individual portions, with seal and clamp closure. Pack of 6.

Item #		Ø"	H"	Capacity
532524	round	4 1/8	4 1/8	1 pint, 6 oz.
532523	round	3 1/8	3 1/8	8 oz.
532522	round	3 1/8	2 3/4	5 oz.



MISE EN BOUCHE SPOONS

Stainless steel spoon to present pre-appetizer delicacies.

Item #		L"	Wt
051291	pack of 12	4 7/8	4 oz.



MINI APPETIZER/JAM JAR

Made of glass for serving individual portions, with seal and clamp closure. Cannot be sterilized. Hermetic.

Item #		Ø"	H"
532526	round	pack of 24	1 5/8
532530	square	pack of 24	2
532529	round	pack of 12	2 1/2



GIESSER HAM KNIFE

Item #	blade L"	Item #	blade L"
182116	9 3/4	182119	serrated 9 3/4
182118	12 1/4	182121	serrated 12 1/4
182126	14	182122	serrated 14



MORE ON GIESSER KNIVES P. 173

BOILED EGG DISPLAY HOLDERS

Made of chromed wire. To attractively display eggs and salt shaker on counter of bars and bistros.



Item #		Wt
N4112	9 egg display holder	6 oz.

SERRANO HAM HOLDER

Used for cutting ham with leg & bone. Constructed of heavy-duty varnished beech-wood. Stainless steel parts hold ham in place.



Item #	L"	W"	H"	Wt lbs.
120524	18 7/8	9	5 1/8	6



HAM HOLDER

Brown polyethylene model. Tray's thickness 1" (25mm).

Item #	L"	W
120526	19 2/3	7 7/8



Transparent macaroon display stand for window, shop and buffet presentations. With adjustable dividers, ideal for renewing assortments displays. PMMA. Can be washed by hand. Dishwasher not recommended.



MACAROON DISPLAY STAND

7 rows of macaroons Ø 40 mm (1 5/8").

Item #	L"	W"	H"	Model
610560	18	13	5 3/4	Inclined

MACAROON DISPLAY STAND

5 rows of macaroons Ø 35 mm (1 3/8").

Item #	L"	W"	H"	Model
610561	12 3/4	12 3/8	2 1/2	Flat



MINI-PYRAMID MACAROONS DISPLAY

4 level trays, total capacity of about 48 macaroons. Pyramid in black PS. Pack of 6.

Item #	H"	Bottom W
681598	7 1/3	7

PYRAMID MACAROONS DISPLAY

This system of nestable trays provides numerous ways to decorate a shop window, buffet or reception table.

Item #	H"	Bottom W	Color
681590	17 1/3	11 7/8	clear
681592	17 1/3	11 7/8	black



- Plastic thermoformed trays.
- Fits 210 macaroons of 1 7/8" diameter.



SEE NON-STICK MAT FOR MACAROONS P. 70





OYSTER KNIFE

Stainless steel blade. Wood handle.

Item #	blade L" (without guard)	Wt oz.
121042	2 3/8	1



OYSTER KNIFE

Stainless steel blade. Plastic handle. Dishwasher safe.

Item #	L"
090420	6



OYSTER KNIFE

Stainless steel blade. Plastic handle. Dishwasher safe.

Item #	blade L" (with guard)
121045	5 1/2



OYSTER FORK

Made of stainless steel. 3 prong fork. Pack of 12.

Item #	L"
062155	4 7/8



LOBSTER CRACKERS

Cast aluminum covered with special coating for dishwasher.

Item #	L"	W"
661201	5 3/4	2 1/2



LOBSTER SCRAPER

Stainless steel. Pack of 12.

Item #	L"
062130	7 1/2



SEA URCHIN OPENER

Made of stainless steel.

Item #	Wt oz.
N4174	5



SEA URCHIN SCISSORS

Extremely sharp steel chrome blades.

Item #	L"
121135	6



**SCALLOP SHELL KNIFE
ERGOBLUE**

XL blade 110 mm [4 1/3"]. Blue ergonomic handle.

Item #	L"
121050	8 7/8



SMALL FISH SCISSORS

Scissors with short, pointed blade to open small fish with precision. Serrated blade to prevent slipping.

Item #	L"
121133	7 1/8



STAINLESS STEEL SEAFOOD TRAY
Made of 18/10 stainless steel.

Item #	Ø"	H"	Wt
713730	12	1 1/2	1 lb. 8 oz.
713735	13 3/4	1 1/2	1 lb. 10 oz.
713740	15 3/4	1 1/2	1 lb. 12 oz.
713745	17 3/4	2	2 lbs. 8 oz.
713750	19 3/4	2 1/2	3 lbs. 3 oz.



LEARN MORE ABOUT THIS PRODUCT
IN OUR CHEF LIFESTYLE BLOG.



MUSSEL POT WITH LID FOR EMPTY SHELLS
Enameled steel with stainless steel rim.

Item #	Ø"	H"	Qts.
070973	7	8 1/4	2 1/2
070975	7	7	27/64
070974	7	5	1 1/2



CHROMED SEAFOOD TRAY HOLDER
Chromed steel wire. Tray not included.

Item #	Top Ø	Bottom Ø	H"	Wt oz.
613302	7 1/2	9 1/2	7 3/4	6



ALUMINUM SEAFOOD TRAY
Round, perfect for buffet. Maintains food at a safe temperature level.

Item #	Ø"	H"	Wt
532330	12	1 1/2	13 oz.
532335	13 3/4	1 1/2	1 lb. 1 oz.
532340	15 3/4	2	1 lb. 11 oz.
532350	19 3/4	2 1/4	2 lbs. 10 oz.



**LIFE
TIME
WARRANTY**



PEPPER MILL "RUSTIC"

Pepper mill made of heavy dark lacquered, wood. Mechanism made of tempered steel with a lifetime warranty.

Item #	H"	Wt
061475	4 1/2	6 oz.
061477	6	7 oz.
061479	8 1/2	10 oz.
061481	10 1/4	1 lb. 1 oz.
061485	16	1 lb. 8 oz.



PORCELAIN BUTTER DISH

With stainless steel lid.

Item #	Ø"	H"
062588	3 1/2	2 3/4



FAT SEPARATOR JUG

Jug to separate fat from juices by decanting. The pouring spout from the base of the jug enables the juices to be collected. SAN graduated. Dishwasher safe.

Item #	Ø"
251010	4 3/4



OIL SPRAYER

Sprays a thin uniform oil layer. Ideal for dressing salads, oiling meat and fish, or greasing trays, pans and molds. Manual air pump. Fitted with filter for spiced oils. Glass body and stainless steel pump.

Item #	Ø"	H"	Capacity	Wt
661404	2 1/6	7	5 3/4 oz.	8 oz.



SUGAR MEASURING POURER

Cover and spout made of stainless steel, glass container. The spout enables easy pouring of sugar for one portion at a time. Economical and hygienic.

Item #	Ø"	H"	Wt
061410	3	4 1/4	10 oz.



BANNETON LINEN LINED BASKET

Crafted of wicker and linen lined. This basket allows you to proof and imprint its shape into all your special and mixed dough. Great for country-style breads and can also be used for tabletop service.

Item #	Type	Ø "	H "	Capacity lbs.
118510	Round	8 1/4	4 3/4	1
118511	Round	9 1/2	4 3/4	2
118512	Round	10 5/8	4 3/4	3
118513	Round	11 1/2	4 3/4	4
118520	Crown	10 1/4	3 1/2	1
118521	Crown	11 3/4	3 1/2	1 1/2
118522	Crown	12 1/2	3 1/2	2 1/6
118523	Crown	13 3/8	3 1/2	3 1/3



WICKER BASKET ROUND LINEN LINED

Ideal for tabletop service.

Item #	Ø "	Wt oz.
573476	8 3/4	4



WICKER BASKET FOR BREAD

Perfect for display of tall loaves of bread such as baguettes, etc.

Item #	Ø "	Wt
573421	11	3 lbs.



POLYPROPYLENE AERATION BREAD BASKET

These bread baskets faithfully reproduce the traditional bread basket shapes and assure aeration of the dough during rising thanks to their special structure.

Dishwasher-safe. Very resistant, they improve the bread preparation hygiene.

Item #	Type	L-W/Ø "	H "	Cap lbs.
118541	Oval	8 1/4 - 5 7/8	3 1/3	1
118547	Round	Ø 7 7/8	3 1/3	1 - 1 1/2
118550	Round	Ø 10 2/3	3 1/3	3 1/3 - 4 3/8



BANNETON WILLOW BASKET

Crafted of Willow. This basket allows you to proof and imprint its shape into all your special and mixed dough. Great for country-style breads and can also be used for tabletop service.

Item #	L "	W "	Wt oz.	Shape
118501	7 7/8	4 3/4	6	oval
118502	9 1/2	6	6	oval
118505	7 1/2	6		round
118506	10 1/4	11		round



Item #	L "	W "	H "	Shape	Capacity of dough
118515	16 1/4	3 3/4	2 1/4	Long	10 oz.
118516	18	4	2 1/4	Long	1 lb.
118525	7	7 1/4	3 1/4	Triangle	1 lb.
118526	9	9	3 1/4	Triangle	2 lbs.
118528	8 3/4	8 3/4	3 1/4	Square	2 lbs.





CHEF SUSAN FENIGER
LOS ANGELES - USA

SMALL APPLIANCES



CHEF-DRIVEN PRECISION ENGINEERED TO EXPAND THE BOUNDARIES OF COOKING.

POLYSCIENCE CULINARY EQUIPMENT

Founded in 1963, PolyScience has 50+ years of expertise in designing and producing precise temperature control equipment for commercial cooking environments. Today, the world's best chefs rely on PolyScience Culinary equipment, which is present in 6 continents and most major cities around the globe. While specializing in Sous Vide immersion circulators, PolyScience Culinary also produces unique items such as the Anti-Griddle and The Smoking Gun.



- Controls up to 30 liter (8 gal.) bath volume.
- Large, back-lit LCD displays set & accurate temperatures
- 1100 watt heater.
- Pump-flow regulation 12 liters (3 gal.) per minute pump.
- Auto-restart.
- 0.07°C stability.
- Ability to calibrate to reference standard.
- Protective Travel & Storage Case.
- Includes "Sous Vide & Precise Temperature Cooking Technique & Recipes" book and a temp reference table.
- Immersion circulator easily clamps on any pot or tank filled with water, transforming it to a precise temperature controlled bath.
- Tanks and lids sold separately.
- 120V, 60Hz, 12 amps.

SOUS VIDE PROFESSIONAL™ IMMERSION CIRCULATOR CHEF SERIES

Item #

073556



- Controls up to 30 liter bath volume
- 1100 watt heater
- 12 liters per minute pump
- 0.05°C stability
- 3 preset temperatures
- Pump-flow regulation
- Auto-restart
- Protective stainless steel cage



SOUS VIDE PROFESSIONAL™ IMMERSION CIRCULATOR CLASSIC SERIES

The original sous vide Immersion circulator for culinary use.

Item #

073559



THE SMOKING GUN® PRO HANDHELD FOOD SMOKER

The Smoking Gun® Pro produces cold smoke, which allows it to be used for any kind of food or liquid. As a flexible hand-held device, it is easy to use for infusion or finishing with a variety of smoky flavors and aromas. The Smoking Gun® Pro offers an alternative to traditional smoking methods. Your selection of combustibles, including various wood chips, teas, herbs, spices, hay, and even dried flowers is limited only by your imagination. The all-new Smoking Gun® Pro features a larger robust housing designed specifically to withstand commercial use. Extra consideration was paid to the smoking barrel as it features tool-less disassembly for easy cleaning and repeated operation. Stability has been improved with the integration of the smoking stand into the handle of the gun. The smoke output can now be precisely controlled with variable fan speed.



POLYCARBONATE TANK FOR IMMERSION CIRCULATOR - 18L

Item #	Overall dimensions **	Capacity
073418	12 x 18 x 9	18 L (4,75 gallons)

CUSTOM-CUT LID FOR 18L TANK

Fits Sous Vide Professional™ CHEF Series Immersion Circulator & 18L Economy Tank (073418)

Item #	Overall dimensions **
073419	12 x 18

POLYCARBONATE TANK FOR IMMERSION CIRCULATOR - 49L

Item #	Overall dimensions **	Capacity
073449	18 x 26 x 9	49 L (13 gallons)

CUSTOM-CUT LID FOR 49L TANK

Fits Sous Vide Professional™ CHEF Series Immersion Circulator & 49L Economy Tank (073449)

Item #	Overall dimensions **
073450	18 x 26

Item #	Wt
185508	1/2 lb



159115



159116



Item #	
159115	Bag of 2,5 beechwood sawdust
159116	Bag of 2,5 beechwood chips



CLASSIC SMOKEHOUSE WOOD KIT

Kit Includes: 4oz. jar of each Applewood, Cherrywood, Hickory and Mesquite all-natural wood chips.

Item #
073558



TEMPERATURE CONTROLLED COMMERCIAL INDUCTION COOKING SYSTEM.



- Temperature Stability $\pm 1^{\circ}\text{F}$.
- Power Range 100 - 1800 Watts.
- Timer: 72 hr with "Repeat, continue, keep warm and stop cooking" functions.
- UL/IEC Commercial Certification.
- NSF Commercial Certification.
- IPX5 Rated Water Protection.
- 2 Year Limited Warranty.
- Includes: Temperature Probe / Pot Clip
- Protective Travel and Storage Case and USB Flash Drive.

THE CONTROL FREAK™ INDUCTION STOVE

Brought to you by Breville® | PolyScience® coming together to bring great design and unparalleled precision to the culinary world.

The Control Freak™ induction cooking system is the first of its kind to accurately measure, set and hold 397 cooking temperatures from 86° - 482°F. The unique real-time sensing system uses a through-glass sensor to directly measure surface temperature. Probe Control™ remote thermometer to precisely control the temperature of both water and fat-based liquids. The Intensity function gives incredible control over the heat up speed to the set temperature. A Create function stores frequently used custom temperature profiles for simple one-touch recall.

Item #	Overall dimensions"	Wt lbs.
073560	18 1/2 x 11 1/3 x 4 1/3	25





ANTI-GRIDDLE® FLASH FREEZE

Traditional cooktop with an amazing twist: instead of heating, the device quickly freezes sauces, purees, vinaigrettes, crèmes, foams, fruits or any type of food! This unique innovation opens a new dimension for your creativity.



ANTI-GRIDDLE®

Surface dimensions 14 1/2" x 9 1/3". 120V, 60Hz, 12 amps.

Item #	L"	W"	H"
073555	15 7/8	18 1/3	10 1/2

- Quickly freezes food into a solid or semi-frozen texture.
- Freezes unique forms or intricate designs.
- -30°C 'griddle' temperature ensures instantaneous results.
- 1 square foot high-endurance stainless steel, easy-to clean surface.
- Create frozen desserts and appetizers with cool, liquid centers. Combine flash frozen lollipops with a novel ingredient in place of traditional sticks. For example, a vanilla caramel ice cream lollipop on a rosemary sprig.
- Top salads with frozen vinaigrettes that melt on the plate when served. Adorn dishes with intricate frozen ornaments, easily transferred from the Anti-Griddle to the plate.
- Flash freeze tableside or at the buffet to provide guests with unique, personal and exciting dining experiences.

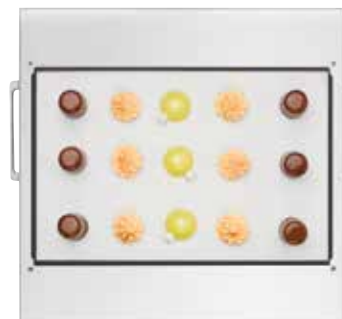

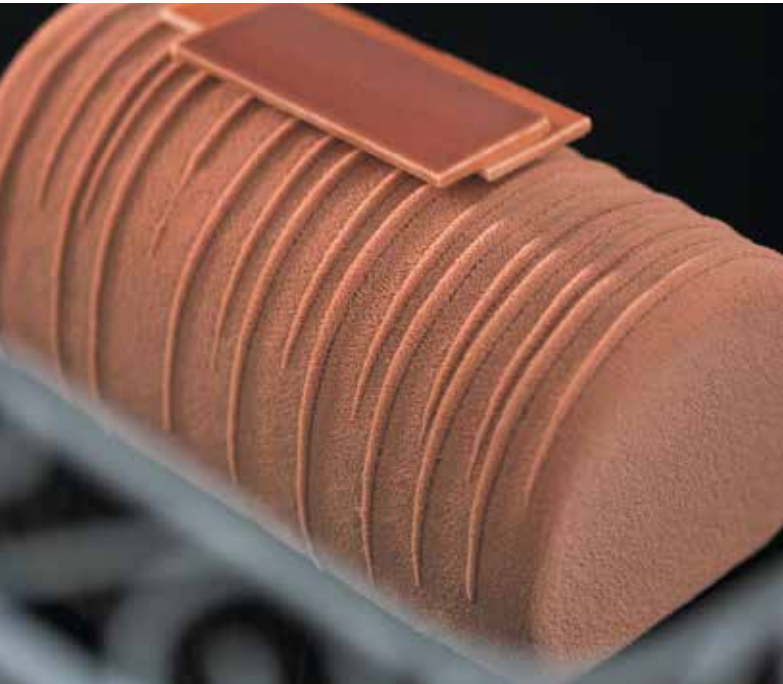

AIRMASTER AIR BRUSH AND COMPRESSOR
Pastry airbrush. Dual comes with 1 air brush and professional compressor. 110V. Adjustable air pressure (0-30 psi). Maintenance free.

Item #	Wt lbs.
410105	8



MORE ON THIS PRODUCT P. 165

IMPERIA ELECTRIC PASTA MACHINE
Ideal for restaurants and group caterings.

Item #	L"	W"	H"
073170	12 1/2	11 3/4	10 1/4

ADJUSTABLE POWER
for controlled product use

DIFFERENT SPRAY
NOZZLE size



ANGLED NOZZLE
extension

ERGONOMIC handle

700 ml screw-in cup
EASY TO CHANGE



MORE ON THIS PRODUCT P. 99



- Heavy duty and easy to clean.
- Hygienic Electrical element detachable to enable dishwashing. • Refrigerator and microwave safe.
- Designed for the kitchen environment.
- Certified as "food safe".
- Handheld & electric-no air compressor needed.
- Simple to use, clean and maintain.



ELECTRICAL SPRAY GUNS

Spraying saves time and reduces material wastage by up to 60% compared to brushing.

M45: food safe spraying for medium-high viscosity such as chocolate, marzipan, glaze etc.

Item #	
264906	ELECTRICAL SPRAY GUN M45



CENTRIFUGAL JUICER "SANTOS"

Base made of aluminum with anodized black waterproof ring to hold bowl. Bowl is made of unbreakable polycarbonate. Easy to clean, juicer dismantles completely. 1 year warranty. 110 volts / 150 watts.

Item #	L"	W"	H"	Wt
991077	12	8	14	12 lbs. 8 oz.

SPARE PARTS

Item #		Wt oz.
880372	plastic grid	1
880374	ring	3
880376	yellow bowl	8
880378	glass stand	8
880380	switch	6
880815	black top cone	2



JUICER EXTRACTOR NO. 68

Dedicated to choose bars, hotels, institutional eating in restaurants as well as intensive use in pastry making-ice cream outlets.

- Powerful and silent motor.
- Extra widechute dia. 79mm (3 1/10") designed to accept most vegetables and fruit, whole.
- All stainless food contact zone.
- Very fine stainless steel strainer (0.5 mm; 1/64") for ideal filtration.
- Ezy-clean system: basket and lid removable without tools.
- Pouring spout 228 mm (9") allowing use of pictures, blender bowls.
- Large capacity pulp receptacle : 14 litres (14 3/4 qts).

Item #	L"	W"	H"
183897	22 1/8	13	23 3/4





Volano on optional stand



MANUAL FLYWHEEL SLICER VOLANO 300
 Red enamelled finish with "Daisy" handwheel and aluminium plate.
 Cutting thickness: 0 to 2.5 mm (0" to 3/32").
 Cutting size : length 9" x height/diameter 7 1/2".

Item #	L"	W"	H"
211205	28 1/3	23 3/4	30

STAND FOR VOLANO SLICER
 Red enamelled steel cast-iron.
 Highlights the slicer and attracts the eye of the customer.

Item #	L"	W"	H"
211207	22	14 3/4	31 1/2



HEAVY DUTY HAND SAUSAGE STUFFER
 18/10 Stainless steel cylinder, nylon piston with O-ring.
 Stainless steel base. Removable crank for operating a 2-speed rack: slow for pushing, quick for piston return.
 Suitable for all meats. Comes with cones of 1/2", 2/3", 1", 1 1/3" Øs. Aluminum mechanism and gears.

Item #	Wt
215605	26 lbs. 10 oz.



VERTICAL MANUAL SAUSAGE STUFFER
 Epoxy frame.
 Stainless steel tank.
 Comes with funnels of 1/3", 2/3", 1" Øs.

Item #	Wt lbs.
N5700	20

THE MOST COMPACT AND ATTRACTIVE ALL-STAINLESS STEEL DESIGNS IN THE INDUSTRY



For over 30 years, American Eagle Food Machinery has been manufacturing and distributing a full line of commercial restaurant and bakery equipment. American Eagle® Meat Grinders feature patented design, all-inclusive accessories, and competitive pricing, making them the best value for foodservice professionals, hunters, butchers or home enthusiasts alike!



AMERICAN EAGLE COMMERCIAL STAINLESS STEEL MEAT GRINDER

Item #	L"	W"	H"	Wt	Ref.
186210	16 1/2	9 1/4	16 2/3	59 lbs.	1 HP
186211	18 1/4	9 2/3	20 3/4	79 lbs.	1.5 HP

- Powerful 1HP (186210) and 1.5 HP (186211) motor.
- 100% Stainless steel grinder head with rifled chamber and quick pass auger reduces jams and food waste
- 100% Durable steel alloy gear driven transmission.
- Permanently lubricated, sealed motor design for food safety and low maintenance.
- Superior electronics and shielded wiring ensure reliable operation.
- Easy to clean, attractive, high polish stainless steel housing with no sharp corners or seams.
- Certified to NSF No.8, CSA, and CE Standards.
- Standard Accessories: Stainless Steel Feeder Pan, Meat Pusher and Stuffer Tube (3/4"), 1/4" (6mm) Stainless Steel Plate, 5/16" (8mm) Stainless Steel Plate, Stainless Steel Knife.
- Standard Features: Forward/Reverse switch* (*Reverse mode should only be used with meat grinder head, using reverse on other attachments may cause damage not covered by warranty), Motor Overload Protection, Reset Button, Standard #12 Hub For Optional Attachments, Non-Slip Rubber Feet, Warranty: 1 Year Limited Warranty. Capacity: 250 lbs./hr (186210) and 450 lbs./hr (186211). 8 Amps (186210) and 16 Amps (186211) 115 V. RPM (Auger):170.



MEAT TENDERIZER ATTACHMENT STAINLESS STEEL

- Large 7" x 1.1" input chute accommodates thick cuts and transforms meat into delicious, salable product.
- 64 heavy duty star shaped knives mounted on two stainless steel shafts knit meat on both sides.
- Attractive high polish stainless steel construction, durable one piece combs prevent stuck meat.
- 180 - 360 lbs./hour capacity.

Item #	L"	W"	H"
186216	12	7 3/8	10 1/4



MEAT CUTTER ATTACHMENT STAINLESS STEEL

- Large 3.5" x 2" input chute accommodates large cuts.
- Can strip or dice tough meat with ease, perfect for stir-fry, fajitas, soups, salads, and more!
- Fixed stainless steel blades with 1/4" spacing.
- Ball bearing mounted shafts designed for high volume.
- Attractive high polish stainless steel construction, durable bottom mounted combs prevent stuck meat.
- 250 - 550 lbs./hour capacity.

Item #	L"	W"	H"	Wt lbs.
186215	9	9	9	12

TRANSFORMA® MANUAL MEAT MINCER

Well-suited to fiddly tasks. Bayonet connector makes changing parts easy. Raised platform for holding plates and bowls. Attaches by clamp or sucker pad to worktops of a thickness of up to 80mm. Delivered with:

- 2 perforated stainless steel plates ø 4.5 mmand 7 mm.
- A stainless steel self-sharpening knife with wing blades.
- A sausage stuffer barrel.
- A special pastry nozzle with 5 different designs.
- A grinder/key.

COMPACT & UNIVERSAL



Item #	L"	W"	Depth
100089	5 1/3	5 1/3	11 2/5





Dimitri Fayard
Executive Chef



CHEF DIMITRI FAYARD
CHICAGO - USA

PROTECTIVE APPAREL





This material allows:

- The skin to breathe.
- Wearing the hat for several days with better sweat absorption, no skin irritation.
- Adjustable head measurement.



DISPOSABLE HATS

Matfer's toques are made of non-woven vegetable fiber combining quality, lightness, comfort and elegance. 30 pleats, no top. Pack of 10.

Item #	H"	Wt
760321	7-1/8	9 oz.
760331	8-3/4	9 oz.



SUGAR WORK GLOVES

Made of latex.

Item #	Size
262289	small
262290	medium
262291	large



PROTECTION MITTS

For heat protection. Made of leather.

Can be used up to 572°F. Oven mitts with forearm protection.

Item #	L"	Wt
773001	4	14 oz.
773002	8	1 lb. 1 oz.



CUT RESISTANT GLOVE

Extra light and certainly safer.

Item #	Size
181062	small
181063	medium
181064	large



PROTECTION GLOVES

Made of leather, with woolen inner layer. 5 fingers. Can be used up to 572°F.

Item #	L"	Wt
773011	4	8 oz.
773012	7 3/4	10 oz.



CUT PREVENTION GLOVE

Offers a high level of protection against cuts. Glove made of glass fiber and polyester knit, is seam free, and flexible for optimum comfort. Recommended in the food industry for cutting meat and cleaning sharp objects or machines such as; knives, electric slicers, etc. Machine washable.

Item #	Size
467012	small
466620	medium
466621	large



Follow



MATFER BOURGEAT USA

<http://www.matferbourgeatusa.com/blog>

<http://www.matferbourgeatusa.com/>



ALPHABETICAL INDEX

A

Adhesive Seal.....89
Adjustable Dough Cutter78
Adjustable Tart Ring49
Air Brush.....99, 220
AirBrush Foldable Cabinet.....98
Allergen Free Knives.....177
Aluminum Brioche Mold Non-Stick
(10 Flutes) Exal28
Aluminum Fluted Quiche Mold
(Non-Stick) Exal.....37
Aluminum Sheet.....74
Anti-Griddle Flash Freeze219
Appetizer Jar.....208
Appetizer Spoon.....208
Apple Corer.....128
Apple Peeler.....155
Apple, Pear Divider.....127
Apron Safety Stainless Steel.....175
Apron, Chocolate.....119
Arabesques Mold.....109
Attachment Meat Cutter.....223
Avocado Peeler, Slicer.....127

B

Baba Draining Box.....27
Bag Clip.....146
Bag, Pastry.....81 to 83
Bag, Pastry Clips.....81
Bag, Pastry Disposable.....82, 83
Bag, Pastry Dryer.....81
Bag, Pastry Holder.....81
Bain-Marie Stainless Steel.....196
Baker's Blade.....18
Baking Beans.....96
Baking Cannele Set Exoglass®24
Baking Mat, Non-stick.....69
Baking Paper.....71
Baking Sheet.....74, 75
Baking Sheet "Dents De Loup".....75
Baking Sheet "Tuiles".....75
Baking Sheets and Mats.... 69 to 72, 74, 75
Banneton Willow Basket.....19, 213
Black Steel Cookware.....192, 197
Black Steel Oven Sheet.....75
Blini Pan.....191, 192, 207
Blini Pan Black Steel.....192, 207
Blow Torch.....97
Blue Steel Oven Baking Sheet.....75
Bottle For Rum Spraying.....145
Boullion Strainer Exoglass®.....140
Bowls, Mixing.....144
Brasier Pan "Excellence".....187
Brasier Pan Copper.....183
Bread Mold.....14 to 16
Bread Sheet Non-Stick Silpain.....69
Brioche Mold.....25, 28, 58, 61
Brixometer.....97

Brush Cooking Silicone.....126
Brush for Pastry Tips.....84
Brush Hygienic Range.....17
Brush Pastry.....95
Buche Cake Comb.....30
Buche Cake Mold.....30 to 33
Burger Chic Porcelain Plate.....204
Butcher's Saw.....176
Butter Curler.....131
Butter Dish.....212
Butter Portioner.....131

C

Cafeteria Tongs.....124, 203
Cake Frame.....46
Cake Marker.....96
Cake Mold.....29, 35 to 38, 64
Cake Pan.....34, 35
Cake Ring.....46
Cake Slicer.....95
Cake Stand Tilting and Revolving.....96
Candy Slicer.....113, 114
Candy Thermometer.....91
Cannele Baking Set Exoglass®24
Cannele Molds.....24, 26, 58, 107
Cannele Replacement Molds
Exoglass®.....24
Cannoli Form Exoglass®29
Casserole "Excellence".....186
Casserole Copper.....183
Casserole, Round Cast Iron.....194, 206
Cassoulet Dish.....207
Cast Iron Cookware.....194, 195, 206, 207
Ceramic Cleaner.....181
Ceramic Cookware.....181
Charlotte Mold.....40
Cheese Grater.....148, 149
Cheese Guillotine.....169
Cheese Knife.....169
Cheese Mill.....149
Cheese Slicer.....169
Cheese Wire Slicer.....169
Cheese, Rotary Grater.....148, 149
Chef Hat.....226
Chef Tongs.....135
Chef Tweezers.....135
Chefs Knife.....171 to 175, 177
Cherry Stoner.....131
China Cap.....141
Chinois.....140
Chocolate Apron.....119
Chocolate Forks.....115
Chocolate Mold Kit.....104
Chocolate Molds.....105 to 112
Chocolate Scraper.....119
Chocolate Sheets.....118
Chocolate Spray Gun.....98
Chocolate Thermometer.....90

Chocolate Transfer Stamp.....116
Chopping Board Rack.....170
Chopping Board Scraper.....170
Chopping Board Scraper Blade.....170
Citrus Juicer.....131
Coarse Grater.....148
Coating Spatula.....116
Colander.....141
Cold Plate.....119
Comb Charlotte.....94
Comb Decorating.....94
Comb Icing.....94
Comb Pastry.....94
Concept "Mozaik".....20, 21
Condibox.....199
Cones Exoglass®29
Cones Mold Flexipan®63
Confectionary Funnel.....100, 101
Confectionary Rack (Stainless Steel).....27
Confectionary Ruler.....116
Container CondiBox.....199
Control Freak Induction Stove.....218
Cookware, Black Steel.....192, 197
Cookware, Copper.....182 to 185
Cookware, Nonstick.....190 to 191
Cookware, Stainless Steel
"Excellence".....186 to 189
Cookware, Tradition.....189
Cooling Rack.....79
Copper Cleaner.....185
Copper Cookware.....182 to 185
Copper Jam Pan.....185
Copper Lid.....182
Copper Set 8 Pieces.....183
Copper Sugar Pan.....185
Corer, Apple.....128, 155, 158
Corer, Fruit and Vegetable.....129
Corer, Pineapple.....129
Corer, Tomato.....128
Crème Brulee Dish.....207
Crepe Pan Black Steel.....192
Crepe Pan Cast Iron.....195
Crepe Pan Ceramic.....181
Crepe Pan Non-Stick.....190
Crepe Spatula.....143
Crepe Spreader.....143
Croissant Cutter.....78
Croquebouche Mold.....40
Crown Muffins Mold Flexipan®60
Crumber, Table.....132
Cupcake/Muffin Mold.....40, 58, 61
Cutlery Giesser Messer.....171 to 177
Cutter, "Pic Vite".....77
Cutter, Dough Wheel.....77, 78
Cutter, Egg (For Flexipan Mold 336190)...64
Cutter, Heart Shaped.....50
Cutter, Lattice Pie.....77
Cutter, Mini Croissant.....78

ALPHABETICAL INDEX

Cutter, Oval Stainless Steel.....77
Cutter, Roller Docker77
Cutter, Spiral Potato.....162
Cutter, Truffle169
Cutters, Exoglass® Fluted.....76
Cutters, Exoglass® Plain76
Cutters, Exoglass® Set76
Cutters, Exoglass® Square.....76
Cutters, Fluted Stainless Steel 20, 77
Cutters, for Flexipans.....64
Cutting Board Drying Rack.....170
Cutting Board Plane170
Cutting Board Scraper.....170

D

Darioles Mold Flexipan®60
Decorating Comb.....94
Decorating Nozzles.....84 to 88
Decorating Pastry Tips84 to 88
Decospoon101
Decospoon Inkwell.....101
Density Meter.....90, 91, 145
Density Meter Tube.....91, 145
Dessert Float92
Digital Thermometer89, 90
Digital Timer91, 145
Dish, Butter.....212
Dish, Cassoulet.....207
Dish, Crème Brulee207
Dishware Earthenware.....206, 207
Display Egg Holder208
Disposable Chef Hat226
Disposable Muffin Mold/Cupcake40
Disposable Pastry Bag.....82, 83
Double Baller.....128
Dough Bike Cutter78
Dough Blade18
Dough Conatiner.....17
Dough Cutter Adjustable78
Dough Fermentation Cloth.....17
Dough Lattice Cutter77
Dough Proofing Basket.....19, 213
Dough Scraper.....92
Dough Wheel Cutter78
Draining Baba Box27
Drying Rack for Linen Liners17
Drying Rack for Pasta.....167
Duck Press.....133
Duo Decorating Tubes88

E

Egg Cutter (For Flexipan Mold 336190)..64
Egg Display Holder208
Egg Knocker, Topper132
Egg Slicer.....132, 160
Egg Topper.....132
Egg Wedger.....132, 158, 160

Egg Whisk138
Electrical Spray Gun99, 220
Electrical Spray Gun parts99
Electronic Thermometer89, 90
Escargot Dish.....206
Escargot Fork206
Escargot Plate206
Escargot Tongs206
Exoglass® Bouillion Strainer.....140
Exoglass® Brioche Mold.....25, 28
Exoglass® Cannele Baking Set24
Exoglass® Cannele Replacement
Molds.....24
Exoglass® Open Savarin Mold.....25
Exoglass® Pelton Spatula.....122, 143
Exoglass® Quiche Mold38
Exoglass® Spoon122
Exoglass® Tart Ring48
Exopan Steel Madeleine Sheet
(Non-Stick).....51
Exopan Steel Non-Stick Open
Savarin Mold26
Exopat Baking Sheet.....69

F

Fat Separator Jug.....145, 212
Fermentation Cloth17
Fiberglass, Non-stick Baking Sheet73
Fine Grater.....148
Fish Knife134, 172, 175
Fish Poacher Stainless Steel196
Fish Scaler135
Fish Shears135, 170
Fish Spatula122, 143
Fish Turner122, 143
Fish Tweezer.....135
Fish, Frying Pan.....191
Flame Tamer197
Flan Mold, Stainless Steel.....41
Flared Rectangular Biroche Mold
(Steel) Exopan.....28
Flexipan Cutters64
Flexipan Flexible Molds.....59 to 67
Flexipat Sheet72
Floor Stand Food Mill164
Flowers Mold Flexipan®60
Fondue Fork.....206
Fondue Pot.....206
Food Mill163, 164
Food Mill Grids.....163, 164
Fork, Chocolate.....115
Fork, Oyster210
Four Sided Grater149
Frame, Extendable Stainless Steel43
Frame, Rectangular.....43
Freezer Thermometer90
Freezing, Anti-Griddle219
French Bread Pan.....16

French Fries Basket202
French Fries Cutter158, 160
French Style Wedding Cake22, 23
Fruit and Vegetable Baller128
Fruit and Vegetable Slicer156 to 161
Fruit Decorating Knife128, 129
Fruit Jelly Molds117
Fruit Tart Mold.....35, 36, 40, 57,
Fruit, Vegetable Shaping
Knives.....116, 128, 129
Fry Pan, "Elite" Non-stick181
Fry Pan, "Excalibur"190
Fry Pan, "Tradition"189
Fry Pan, Black Steel192
Fry Pan, Ceramic181
Fry Pan, Copper184
Fry Pan, Non-stick.....190, 191
Funnel100, 101, 141
Funnel Holder.....101
Funnel, Confectionery100, 101
Funnel, Confectionery Stainless Steel ..101
Funnel, Portion Control.....101
Funnel, Stainless Steel.....101, 141

G

Garlic & Onion Press125, 126
Garlic Tube.....126
Gastroflex Flexible Molds.....51, 56, 57, 58
Gastroflex Stamp Tool61
Giant Reduction Spatula139
Giant Spatula Exoglass®.....139
Giant Whisk139
Ginger Tool.....148
Gloves Cut Prevention226
Gloves Heat Protection.....226
Gloves Sugar Work97, 226
Graduated Pitcher145
Grapefruit Knife128
Grater, Cheese.....147, 148, 149
Grater, Chocolate.....147, 148, 149
Grater, Coarse147, 148, 149
Grater, Elite Box149
Grater, Fine.....147, 148, 149
Grater, Lemon / Ginger147, 148, 149
Grater, Medium.....147, 148, 149
Grater, Parmesan147, 148, 149
Grater, Ribbon148, 149
Grater, Spice147, 148, 149
Grater, Ultimate bar tool.....148
Grater, Zester147, 148, 149
Grid, Freezer79
Grid, Stainless Steel79
Griddle, Reversible195
Guillotine, Cheese.....169
Guitar Slicer.....113, 114
Guitar Slicer Trolley.....113
Gun, Sprayer99, 220
Gun, Sprayer Parts99

ALPHABETICAL INDEX

H

Half Cylinders Mold Flexipan®60
 Half Spheres Mold 110
 Ham Holder.....208
 Hats, Chef226
 Hemisphere Mold41
 Hemispherical Bowl 144
 Herb Mill 149
 Herb Scissors 170
 Hooks for Utensils Wall Rack..... 198

I

Ice Cream Scoop..... 146
 Immersion Circulator Chef Series216
 Immersion Circulator Classic Series...216
 Immersion Circulator Tank217
 Immersion Circulator Tank Lid217
 Induction Stove, Control Freak.....218
 Infrared Thermometer89

J

Jam Pan Copper 185
 Jar Appetizer Glass With Clamp.....208
 Juicer Centrifugal "Santos"221
 Juicer Citrus 131, 221
 Juicer Manual 131
 Juicer, Extractor221

K

Kitchen Scissors 170
 Kitchen Utensil Hanging Rail 197
 Knife Boning Giesser Messer 171, 177
 Knife Bread Giesser Messer 172,
 Knife Chef Giesser
 Messer171 to 173, 176, 177
 Knife, Cheese 169
 Knife, Fish 134, 172
 Knife, Fruit Decorator..... 128
 Knife, Geisser Messer Premium
 Cut..... 173 to 175
 Knife, Geisser Messer Premium
 Cut BBQ..... 174
 Knife, Ham Giesser Messer.. 172, 177, 208
 Knife, Heavy Cleaver..... 176
 Knife, Multi-Purpose / Kitchen..... 171, 172
 Knife, Paring Giesser Messer..... 171, 177
 Knife, Peeling Giesser Messer 130, 171
 Knife, Purple Geisser Messer 177
 Knife, Sandwich / Butter..... 131
 Knife, Scallop-Shell..... 134, 210
 Knife, Serrated Giesser
 Messer171, 172, 177, 208
 Knife, Set Giesser Messer 176
 Knife, Sharpening Steel..... 172
 Knife, Universal Giesser
 Messer 171, 172, 177
 Kugelhopf Mold..... 25, 26, 58

L

Ladle Stainless Steel.....136
 Ladle, Sauce 136
 Lame, Bakers Blade 18
 Larding Needle 133
 Leaf Pastry Tips85
 Lemon, Ginger Grater..... 148, 149
 Lid, "Excellence"..... 189
 Lid, Copper..... 182
 Lid, Tradition..... 189
 Linen Drying Rack.....17
 Loaf, Mold Exoglass® 15, 29
 Lobster Cracker.....210
 Lobster Press 133
 Lobster Scraper.....210
 Log Frame "Letter to Santa Claus"21
 Logs Mold..... 110

M

Macaroons Mat70
 Macaroons Pyramid Display.....209
 Madeleine Sheet Exopan51
 Mandoline 152, 153, 154
 Mandoline 1000..... 154
 Mandoline 1000 Spare Parts 154
 Mandoline 2000..... 152
 Mandoline 2000 Spare Parts 152
 Mandoline Bron 154
 Mandoline Bron Spare Parts 154
 Mandoline Stainless Steel..... 153, 154
 Mandoline Stainless Steel Spare
 Parts..... 153, 154
 Mandoline, Japanese Benriner
 "Big Beni" 154
 Mandoline, Japanese Benriner
 "Little Beni" 154
 Mango Splitter 127
 Manual Juicer 131
 Marzipan Sculpting Tools 116
 Matfer Prep Chef 156 to 161
 Matfer Prep Chef Mini 156
 Matfer Prep Chef Storage Shelf 161
 Measuring Pitchers 145
 Measuring Scoops 146
 Measuring Spoons 146
 Meat Cutter Attachment.....223
 Meat Grinder (Stainless Steel)223
 Meat Mincer223
 Meat Tenderizer Attachment
 (Stainless Steel).....223
 Meat Tenderizer PEHD 175, 223
 Melon Decorating Knife..... 128
 Melon Divider..... 127
 Mesh Sieve93
 Mezzaluna Blade..... 170
 Microplane, Graters..... 147, 148, 149
 Mill, Cheese 149
 Mill, Herb 149

Mill, Pepper.....212
 Mini Bars Mold..... 106, 110
 Mini Guitar 114
 Mixing Bowl Hemispherical Stand 144
 Mixing Bowls Hemispherical
 Stainless Steel 144
 "Mixing Bowls Hemispherical
 Polypropylene" 144
 Mixing Bowls Stainless Steel Flat
 Bottom 144
 Mold Tartlet "MOZAİK" (Oval).....20, 21
 Mold, Baba Round Exoglass®.....25, 27
 Mold, Baba Round Exopan.....27
 Mold, Baba Round Stainless Steel27
 Mold, Biroche Mold Non-Stick (14 Flutes)
 Exopan.....28
 Mold, Bread..... 14, 15, 16
 Mold, Brioche..... 25, 28, 58, 61
 Mold, Buche Cake 30, 31, 32, 33
 Mold, Cake 24, 29, 35, 36, 37, 38, 64
 Mold, Cannele 24, 26, 58, 107
 Mold, Chocolate 105 to 112
 Mold, Cone29
 Mold, Croquembouche Stainless Steel..40
 Mold, Crown Muffins Flexipan®60
 Mold, Darioles Flexipan®.....60
 Mold, Exal 28, 37
 Mold, Exoglass®..... 14, 15, 24, 25,
 27, 28, 29, 37, 38, 39
 Mold, Exoglass® Quiche38
 Mold, Exopan..... 15, 26, 27, 28,
30, 34, 35, 36, 39, 40, 41, 42, 51
 Mold, Flexible..... 51 to 67
 Mold, Flexipan..... 51, 59 to 67
 Mold, Flowers Flexipan®60
 Mold, Fluted Quiche..... 37, 39, 40
 Mold, Gastroflex..... 51, 56, 57, 58
 Mold, Half Sphere57, 62, 106, 112
 Mold, Half-Cylinders Flexipan®60
 Mold, Heart 50, 53, 105,
 106, 108, 111, 117
 Mold, Hemisphere41
 Mold, Jelly Fruit Flexible 117
 Mold, Kugelhopf Exoglass®.....25
 Mold, Kugelhopf Exopan Non-stick.....26
 Mold, Loaf Exoglass®29
 Mold, Madeleine 51, 57, 62
 Mold, Meat Pie Exopan42
 Mold, Medallions Flexipan®61
 Mold, Mini Pate Exopan42
 Mold, Mini-Cylinders Flexipan®62
 Mold, Mozaik Square Tart.....21
 Mold, Open Savarin (Steel
 Non-Stick) Exopan.....26
 Mold, Oval Flexipan®60
 Mold, Oval Pate Exopan42

ALPHABETICAL INDEX

Mold, Oval Tartlet "Mozaik"	21
Mold, Petit Four	40
Mold, Pomponnette Non-stick	41
Mold, Quiche Exoglass®	38
Mold, Ramekin Exoglass®	25
Mold, Ravioli.....	168
Mold, Silikomart	52 to 55
Mold, Tart.....	21, 36, 48, 49, 61
Mold, Tartlet	21, 25, 35 to 39, 57, 61
Mousse Frame	44, 46,
Mousse Ring	47
Mozaik Concept.....	20, 21
Muffin/Cupcake Mold.....	40, 58, 60, 61
Muffin/Cupcake Mold Disposable	40
Mushroom Slicer	126
Mussel Pot	211

N

Needle, Thermometer	89
Needle, Vacuum Packing.....	89
Non- Stick Aluminum Brioche Mold (10 Flutes) Exal	28
Non-stick Baking Sheet Exopat.....	69
Non-Stick Bread Mold (Flared) Exopan...	15
Non-stick Cookware	190, 191
Non-Stick Open Savarin Mold Exopan.....	26
Non-Stick Steel Brioche Mold (10 Flutes) Exopan	28

O

Offset Spatula	43, 143
Oil Spray Gun	98
Oil Sprayer	145, 212
Olive Stoner.....	131
Onion & Garlic Press	126
Onion Cutter.....	158
Opener, Sea Urchin.....	134, 210
Oval "Mozaik" Tartlet Mold	21
Oval Cake Mold, Exoglass®	38
Oval Frying Pan.....	191
Oval Shells Mold	106
Oven Baking Sheet.....	75
Oyster Fork	210
Oyster Knife	134, 210

P

Pack Down Tool For Molds/ Rings	50
Paella Pan, Black Steel	197
Paella Pan, Polished Steel	197, 207
Paper clip.....	72
Parmesan Grater	148
Pasta Cooker/Strainer.....	188
Pasta Cylinders.....	165, 166
Pasta Dryer	167
Pasta Machine	165 to 167, 220
Pasta Machine Maintenance Kit.....	165
Pasta Ravioli Mold	168

Pastry Bag Clips	81
Pastry Bag Dispenser.....	82
Pastry Bag Dryer	81
Pastry Bag Holder	81
Pastry Bags.....	81 to 83
Pastry Brush	95
Pastry Brush Silicone	95
Pastry Comb	94
Pastry Crimper Tong	93
Pastry Cutters Exoglass®	76
Pastry Cutters Stainless Steel	77
Pastry Float.....	92
Pastry Ribbon.....	47
Pastry Tips	84 to 87
Peeler Professional.....	130
Pepper Mill.....	212
Perforated Oven Sheet	75
Perforated Serving Spoon	124, 203
Petit Dishes.....	204, 205
PH Meter	89
Piano Whisk	138
Pickle Slicer 8 Blade.....	126
Pie Cutter	77
Pie/Cake Marker.....	96
Pineapple Corer.....	129
Pizza Cutter.....	168
Pocket Thermometer	89, 90
Polycarbonate Chocolate Molds.....	105 to 112
Pomponnette Mold	41
Porcelain Dish.....	202, 204, 205
Potato Masher Prep Chef	161
Potato Steamer Copper	187
Poultry Needle.....	133
Poultry Shears	170
Prep Chef	156 to 161
Prep Chef Storage Shelf.....	161
Press, Duck / Lobster.....	133
Pressure Cooker.....	196
Pressure Cooker Basket	196
Pressure Cooker Regulator	189
Professional Shaver	148
Pyramid Macaroons Display.....	209

R

Rack, Confectionary.....	79
Rack, Cooling Round With Feet.....	79
Rack, For Pastry Tips.....	87
Radish Decorator	126
Ramekin Mold.....	25, 40
Ravioli Mold.....	168
Refractometer	97, 185
Revolving Cake Stand	96
Ribbon Grater	148
Ribbon Nozzles	88
Ribbon, Pastry.....	47

Rigid Whisk	138
Ring (Round)	47, 48, 49, 50
Ring, Adjustable.....	49
Ring, Cake.....	47
Ring, Entremets.....	47
Ring, Exoglass	48
Ring, Mousse Stainless Steel	47
Ring, Nonnette Stainless Steel	50
Ring, Pack Down Tool.....	50
Ring, Party Bread Stainless Steel	49
Roast Pan.....	191, 196
Roller Docker.....	77
Roller Strip Cutter	78
Rolling Pin.....	80
Rosary Mold	34
Rotary Cheese Mill.....	149
Rotary Food Mill.....	163, 164
Rotary, White Grater.....	148
Roul'pat Mat.....	73
Rubber Spatula	123
Ruler Confectionery.....	116
Ruler Mousse Frame.....	44
Ruler, Buche	30

S

Saint-Honore Pastry Tips	85
Salad Spin Dryer	142
Salad Spin Dryer parts	142
Salometer	90
Sauce Pan "Excellence"	188
Sauce Pan, Copper	182, 185
Sauce Pot "Excellence"	188
Sauce Syringe	133
Sauce Whisk.....	138, 139
Sausage Stuffer	222
Sauté Pan "Excellence"	188
Sauté Pan Flared "Tradition"	189
Sauté Pan, Copper	184
Savarin Open Mold Exoglass®.....	25
Sawdust for Smoking Gun	217
Scaler, Fish	135
Scissors.....	97, 134, 170
Scissors, Herb.....	170
Scissors, Kitchen	170
Scissors, Sea Urchin.....	134, 210
Scissors, Shelling	134
Scissors, Small Fish	134, 210
Scissors, Sugar	97
Scoop, Ice Cream.....	146
Scooping Spoon	128
Scraper	92, 93, 118, 119, 123, 170, 210
Scraper, Dough.....	92
Scraper, Silicone.....	93, 118, 119
Sculpting Tools	116
Seafood Tray Holder	211
Seafood Tray Stainless Steel.....	211
Seafood Tray, Aluminum	211

ALPHABETICAL INDEX

- Serving Spoon 124, 203
 Serving Utensils, Exoglass® 124, 203
 Sharpening Steel 172
 Shaver 148, 149
 Shears, Fish 135, 170
 Shears, Poultry 170
 Sheet, "Dents De Loup" Stainless Steel 75
 Sheet, Chocolate 118
 Sheet, Oven Black Steel 75
 Sheet, Oven Embossed Exal® 74
 Sheet, Oven Nonstick Aluminum 74
 Sheet, Oven Round Black Steel 75
 Shellfish Cracker 210
 Shelling Scissors 134
 Sieve 93
 Sieve Flour Automatic 93
 Sieve, Set of 3 Mesh 93
 Silform Flexible Mold 16, 66, 67
 Silform Sub Rolls 16
 Silicone Cooking Brush 126
 Silicone Molds - Flexipan® 51, 59 to 67
 Silicone Molds - Gastroflex 56 to 58
 Silicone Molds - Silikomart 52 to 57
 Silpain Baking Sheet 69
 Silpat Mat for Macaroons 70
 Sizzle Platter 207
 Skimmer, Exoglass 137
 Skimmer, Stainless Steel 136, 139
 Slicer Volano 222
 Slicer, Fruit / Vegetable 126, 127, 129,
 149, 152, 153, 155, 156 to 162
 Slicer, Ham 222
 Smoking Gun®PRO 217
 Smooth Edgeless Baking Sheet 73
 Sous Vide Container 217
 Sous Vide Immersion Circulator 216
 Spatula, Bent Exoglass® 43, 73, 143
 Spatula, Bent Turner 122, 143
 Spatula, Elveo Rubber 123
 Spatula, Elveo Rubber with
 Thermometer 90, 125
 Spatula, Exoglass with
 Thermometer 90, 125
 Spatula, Exoglass® 122, 123
 Spatula, Fish Stainless Steel 122
 Spatula, Flat Bevelled Exoglass® 122
 Spatula, Flexible Blade 43, 143
 Spatula, Giant 139
 Spatula, Icing 92
 Spatula, Kitchen Exoglass® 123
 Spatula, Offset 43, 143
 Spatula, Pelton 122
 Spatula, Scraper 123
 Spatula, Spatulon 123
 Spatula, Thermometer 90, 125
 Spatula, Triangle 116
 Spice Box 199
 Spice Grater 147
 Spice Infuser 197
 Spiral Julienne Curler 129
 Spiral Knife 129
 Spiral Potato Cutter 162
 Spiral Vegetable Slicer 162
 Spiral Whisk 139
 Sponge, Cake Mold (Removable
 Bottom) Exopan 36
 Spoon Exoglass® 122, 124
 Spoon Mise En Bouche Stainless Steel .. 208
 Spray Gun 94, 99, 220
 Sprayer, Oil 145, 212
 Sprayer, Rum 145
 Spring Form Pan 34
 Square Dome Mold 109
 Square Pan 34
 Square Shells Mold 106, 109
 Stackable Mousse Frame 44, 45
 Stackable Nestable Container 19
 Stainless Steel "Mozaik Tartlet"
 (Oval Mold) 21
 Stainless Steel Confectionary Rack 27
 Stainless Steel Cookware 186 to 189
 Stainless Steel Cookware Cleaner 186
 Stainless Steel Meat Grinder 223
 Stainless Steel Round Bread Pan
 (Small) 16
 Stainless Steel Tart Ring 49
 Stainless Steel Tongs 135, 143
 Steamer "Excellence" 187
 Stockpot "Excellence" 187, 188
 Stockpot With Faucet "Excellence" 188
 Stoner, Cherry / Olive 131
 Strainer 140, 141
 Strainer Holder 140
 Strainer Stainless Steel 141
 Strainer, Bouillon Exoglass® 140
 Strainer, Sieve Exoglass® 141
 Strip Cutter 78
 Stuffer, Sausage 222
 Sub Rolls, Silform 16
 Sugar Pan, Copper 185
 Sugar Pourer 145
 Sugar Pump 97
 Sugar Scissors 97
 Sugar Work Gloves 97, 226
 Sultane Pastry Tips 86
 Swing Salad Spin Dryer 142
 Swing Salad Spin Dryer parts 142
 Syringe 133
 Syrup Density Meter 90
 Syrup Density Meter Tube 91
- T**
 Table Cumber 132
 Tart Mold Fluted (Removable
 Bottom) Exopan 36
 Tart Ring (Stainless Steel) 49
 Tart Ring, Exoglass® 48
 Tart Rings 48, 49
 Tartlet Mold 21, 25, 35 to 39, 57, 61
 Tenderizer, Meat (Attachment) 223
 Terrine, Cast Iron 194
 Thermometer, Candy 90, 91
 Thermometer, Chocolate 90
 Thermometer, Digital 89, 90
 Thermometer, Electronic 89, 90
 Thermometer, Freezer 90
 Thermometer, Holder 91
 Thermometer, Infrared 89
 Thermometer, Needle 89
 Thermometer, Pocket 89, 90
 Thermometer, Probe 89
 Thermometer, Spatula 90, 125
 Thermometer, Vacuum Needle 89
 Timer 91, 145
 Tomato Corer 128
 Tomato Slicer 158, 159
 Tomato Wedger 158, 159
 Tomato, Kiwi Peeler 130
 Tongs, Cafeteria 124, 203
 Tongs, Duolon 122
 Tongs, Escargot 206
 Tongs, Exoglass® 124, 203
 Tongs, Fish Bone 135
 Tongs, Pastry Crimper 93
 Tongs, PVC Handle 143
 Tongs, Stainless Steel 143
 Tongs, Topping 135
 Torch 97
 Tray + Grid Stainless Steel 197
 Trolley for Dough Containers 17
 Truffle Cutter 169
 Truffle Mold 109
 Truffle Slicer 169
 Tweezers 135
- U**
 Utensil Rack 198
 Utensil Shelf 198
- V**
 Vacuum, Thermometer Needle 89
 Vegetable Baller Double 128
 Vegetable Peeler 130
 Vegetable Slicer "Le Rouet" 162
 Vegetable Steamer, Stainless Steel 187
 Vegetable Turning Décor 129
 Vegetable Turning Slicer 162
 Volcano Mini Mold Flexipan® 60
 Volcano Mold Flexipan® 60

ALPHABETICAL INDEX

W

Wall Rack Holder	139
Waves Mold	110
Wedding Cake French Style	22, 23
Wedge Fruit / Vegetable.....	156 to 160
Whisks.....	138, 139
White Adhesive Seal	89
Wicker Bread Basket.....	19
Wire Skimmer	136
Wok "Tradition".....	189
Wok Ceramic.....	181
Wok Non-stick	190
Wood Chips for Smoking Gun.....	217
Wood Kit for Smoking Gun	217
Wooden Sieve.....	93
Writing Pastry Bags (With Tips).....	83

Y

Yule Log Pastry Tips	84 to 88
----------------------------	----------

Z

Zen100 "Silikomart"	55
Zen300 "Silikomart"	55
Zen600 "Silikomart"	55
Zester	126, 147, 149

NUMERICAL INDEX

Item #	Page #	Item #	Page #	Item #	Page #	Item #	Page #	Item #	Page #
013203.....	196	062002.....	192	072271.....	89	111035.....	138	112826.....	92
013204.....	196	062003.....	192	072525.....	169	111036.....	138	112840.....	92
013206.....	196	062004.....	192	072580.....	169	111046.....	138	112845.....	92
013227.....	196	062005.....	192	072595.....	169	111055.....	139	112900.....	92
013230.....	196	062006.....	192	072703.....	129	111060.....	139	112901.....	92
013231.....	196	062007.....	192	072770.....	127	111061.....	139	112902.....	92
013320.....	196	062008.....	192	072773.....	127	111892.....	72	112903.....	92
015210.....	188	062009.....	192	072890.....	126	112011.....	139	113025.....	123
017082.....	199	062031.....	192	072892.....	126	112012.....	139	113030.....	123
017084.....	199	062032.....	192	072897.....	126	112013.....	139	113035.....	123
017241.....	141	062033.....	192	072900.....	131	112015.....	139	113040.....	123
017242.....	141	062034.....	192	073085.....	131	112021.....	136	113041.....	123
017335.....	141	062040.....	192, 207	073095.....	131	112022.....	136	113042.....	123
017337.....	141	062051.....	197	073135.....	135	112023.....	136	113045.....	123
017360.....	140	062052.....	197	073140.....	166	112024.....	136	113050.....	123
017360MC.....	140	062053.....	197	073141.....	166	112025.....	136	113090.....	90, 125
017362.....	140	062075.....	206	073159.....	168	112026.....	136	113092.....	90, 125
017362MC.....	140	062130.....	210	073170.....	165, 220	112028.....	136	113330.....	122
017364.....	140	062150.....	206	073171.....	165	112030.....	139	113331.....	122
017365.....	140	062155.....	210	073175.....	167	112061.....	136	113332.....	122
020280.....	131	062160.....	206	073180.....	165	112062.....	136	113334.....	122
020420.....	141	062588.....	212	073181.....	165	112063.....	136	113338.....	122
020422.....	141	070522.....	197, 207	073182.....	165	112064.....	136	113345.....	122
020424.....	141	070528.....	197, 207	073183.....	165	112065.....	136	113501.....	123
020426.....	141	070971.....	195, 206	073184.....	165	112066.....	136	113720.....	123
034101.....	185	070973.....	211	073186.....	165	112282.....	137	113724.....	123
034103.....	185	070974.....	211	073194.....	168	112293.....	136	113735.....	123
050044.....	204	070975.....	211	073195.....	168	112295.....	136	113745.....	123
050061.....	202	070988.....	197	073200.....	168	112298.....	136	113825.....	123
050063.....	202	070990.....	197	073227.....	78	112419.....	122	113833.....	123
050065.....	202	070992.....	197	073229.....	167	112420.....	122	114005.....	123
050464.....	204	071038.....	197, 207	073418.....	217	112421.....	122	114006.....	93, 118
050468.....	205	071041.....	197, 207	073419.....	217	112422.....	122	115012.....	93
051132.....	205	071050.....	197, 207	073449.....	217	112424.....	122	115020.....	93
051136.....	202	071052.....	197, 207	073450.....	217	112425.....	122	115060.....	93
051165.....	204	071058.....	195	073555.....	219	112429.....	122	115082.....	93
051291.....	208	071070.....	194	073556.....	216	112430.....	122	115084.....	93
051354.....	204	071072.....	194	073558.....	217	112443.....	128	116002.....	95
051356.....	205	071074.....	194	073559.....	216	112501.....	135	116004.....	95
051357.....	204	071076.....	194	073560.....	218	112503.....	135	116006.....	95
051359.....	204	071098.....	194, 206	073597.....	196	112641.....	116	116008.....	95
052023.....	205	071122.....	195	079611.....	195, 207	112650.....	43, 143	116009.....	95
052278.....	207	071230.....	139	090347.....	169	112652.....	43, 143	116011.....	95
052280.....	207	071351.....	197	090384.....	1230	112654.....	43, 143	116012.....	95
052284.....	207	071452.....	141	090417.....	128	112656.....	43, 143	116013.....	95
052300.....	205	071456.....	141	090420.....	134, 210	112657.....	96	116014.....	95
059925.....	207	071694.....	143	090570.....	170	112664.....	143	116015.....	95
061410.....	145, 212	071696.....	143	100089.....	223	112666.....	143	116016.....	95
061475.....	212	071698.....	143	100110.....	176	112670.....	43, 143	116017.....	95
061477.....	212	071699.....	143	100115.....	176	112672.....	43, 143	116018.....	95
061479.....	212	071940.....	143	111022.....	138	112674.....	43, 143	116020.....	95
061481.....	212	071945.....	143	111023.....	138	112676.....	43, 143	116201.....	146
061485.....	212	071950.....	143	111024.....	138	112686.....	43, 143	116202.....	146
061607.....	132	072029.....	146	111025.....	138	112722.....	116	116204.....	146
061715.....	206	072045.....	143	111026.....	138	112822.....	92	116208.....	146
062001.....	192	072200.....	97	111027.....	138	112825.....	92	116220.....	141

NUMERICAL INDEX

Item #	Page #	Item #	Page #	Item #	Page #	Item #	Page #	Item #	Page #
116351	144	120524	208	141029	78	161205	81	167101	86
116352	144	120526	208	141031	168	161206	81	167103	86
116353	144	120802	170	141105	77	161207	81	167104	86
116354	144	120806	170	141110	77	161208	81	167105	86
116355	144	120807	134	141115	77	165003	83	167106	86
116356	144	120817	170	141120	77	165003-MASTER		167107	86
116430	145	120841	133	150101	76	CASE	83	167108	86
116436	101	120842	133	150102	76	165003-PALLET	83	167109	86
116437	101	120852	133	150103	76	165007	82	167110	86
116451	144	120901	130	150104	76	165010	82	167111	86
116452	144	120903	126	150110	76	165015	82	167112	86
116453	144	120906	130	150111	76	165015MC	82	167113	86
116454	144	120907	129	150112	76	165015P	82	167114	86
116455	144	120910	126	150113	76	165018	82	167115	86
116456	144	120912	128	150114	76	165018-MASTER		167130	85
116515	101, 140	120913	129	150115	76	CASE	82	167140	86
116530	101	120916	128	150117	76	165018-PALLET	82	167141	85
116540	100	120920	131	150119	76	165019	82	167142	85
116601	100	120925	128	150121	76	165019-MASTER		167151	85
116605	101	120932	129	150123	76	CASE	82	167152	85
118501	19, 213	120938	129	150125	76	165019P	82	167170	85
118502	19, 213	120939	162	150126	76	165030	82	167171	86
118505	19, 213	121009	128	150127	76	166003	84	167175	88
118506	19, 213	121021	131	150151	76	166004	84	167180	85
118510	19, 213	121042	134, 210	150152	76	166006	84	167300	85
118511	19, 213	121045	134, 210	150153	76	166007	84	167302	85
118512	19, 213	121050	134, 170, 210	150154	76	166010	85	167303	85
118513	19, 213	121100	135	150155	76	166160	86	167304	85
118515	19, 213	121103	135	150157	76	166161	86	167306	85
118516	19, 213	121133	134, 170, 210	150159	76	166500	87	167333	85
118520	19, 213	121134	135, 170	150161	76	166700	87	167345	85
118521	19, 213	121135	134, 210	150163	76	167012	86	167355	85
118522	19, 213	121136	135	150165	76	167014	86	167370	85
118523	19, 213	122011	169	150220	77	167015	86	167380	85
118525	19, 213	122012	169	150230	77	167023	86	167430	85
118526	19, 213	122013	169	150231	77	167024	86	167452	85
118528	19, 213	122016	169	150232	77	167025	86	167532	87
118541	19, 213	122017	169	150241	76	167033	86	167900	87
118547	19, 213	122021	169	150244	76	167034	86	168001	88
118550	19, 213	122031	169	150247	76	167035	86	169001	81
118560	17	139002	170	150320	77	167042	86	169002	81
118580	17	139005	170	153046	64	167043	86	169003	81
118991	146	139006	170	153052	64	167044	86	181009	129
120005	18	140005	80	153190	64	167045	86	181046	175
120006	18	140010	80	154051	96	167051	86	181048	175
120022	18	140018	80	154052	96	167053	86	181052	129
120023	18	140028	80	159115	217	167054	86	181062	226
120025	18	140030	80	159116	217	167055	86	181063	226
120026	18	140102	61	161002	81	167062	86	181064	226
120032	18	140126	80	161003	81	167064	86	181901	173
120034	18	140204	116	161004	81	167065	86	181902	173
120035	18	141002	78	161005	81	167080	86	181903	173
120054	18	141004	78	161006	81	167082	86	181904	173
120090	96	141006	78	161007	81	167084	86	181911	174
120092	96	141010	78	161008	81	167086	86	181912	174
120451	170	141013	78	161204	81	167088	86	181913	174

NUMERICAL INDEX

Item #	Page #	Item #	Page #	Item #	Page #	Item #	Page #	Item #	Page #
181914.....	174	215001.....	153	215610.....	157	250112.....	91, 145	258313.....	54
181921.....	175	215005.....	153	215611.....	159	250122.....	97, 185	258314.....	53
181922.....	175	215010.....	153	215613.....	159	250124.....	97, 185	258315.....	55
181923.....	175	215017.....	153	215615.....	158	250128.....	97	258316.....	55
181924.....	175	215018.....	153	215616.....	158	250130.....	97	258317.....	55
181991.....	176	215021.....	153	215618.....	158	250152.....	89	258825.....	101
181992.....	176	215022.....	153	215619.....	158	250301.....	90	261908.....	118
181993.....	176	215023.....	153	215626.....	158	250305.....	90	262001.....	115
181994.....	176	215028.....	154	215627.....	158	250330.....	91	262002.....	115
182101.....	171	215029.....	154	215628.....	158	250331.....	91	262010.....	115
182102.....	171	215030-035.....	154	215640.....	161	250332.....	91	262012.....	115
182103.....	171	215030.....	154	215641.....	161	250500.....	91	262013.....	115
182104.....	171	215035.....	154	215642.....	161	250502.....	90	262014.....	115
182106.....	171	215040.....	154	215650.....	158	250513.....	90	262015.....	115
182110.....	172	215043.....	154	215651.....	158	250528.....	89	262016.....	115
182112.....	172	215044.....	154	215690.....	161	250536.....	89	262017.....	115
182113.....	172	215045.....	154	215731.....	160	250538.....	89	262019.....	115
182116.....	172, 208	215046.....	154	215732.....	160	250544.....	89	262020.....	115
182118.....	172, 208	215052.....	169	215734.....	160	250552.....	89	262021.....	115
182119.....	172, 208	215060.....	152	215735.....	160	250555.....	89	262022.....	115
182121.....	172, 208	215065.....	152	215736.....	160	250601.....	91, 145	262023.....	115
182122.....	172, 208	215068.....	152	215738.....	160	250602.....	91, 145	262024.....	115
182125.....	172	215070.....	152	215742.....	160	251001.....	145	262030.....	116
182126.....	172, 208	215072.....	152	215744.....	160	251003.....	145	262230.....	97
182129.....	171	215074.....	152	215745.....	160	251005.....	145	262235.....	97
182131.....	134, 172	215085.....	152	215746.....	160	251010.....	145, 212	262263.....	97
182151.....	172	215086.....	152	215748.....	160	257901.....	57	262289.....	97
182783.....	176	215112.....	153	215758.....	160	257904.....	57	262290.....	97
182803.....	177	215115.....	153	215768.....	160	257905.....	58	262291.....	97
182804.....	177	215121.....	162	215790.....	160	257912.....	51, 57	263500.....	113
182812.....	177	215124.....	162	215791.....	160	257914.....	58	263512.....	113
182813.....	177	215131.....	162	215792.....	160	257915.....	58	263530.....	114
182821.....	177	215132.....	162	215794.....	161	257916.....	58	263535.....	114
182829.....	177	215155.....	155	215795.....	161	257917.....	51, 57	263537.....	114
183896.....	148	215158.....	155	215796.....	161	257920.....	57	263540.....	113
183897.....	221	215250.....	155	215797.....	161	257921.....	57	263542.....	113
185508.....	217	215255.....	155	215798.....	161	257922.....	57	263543.....	113
186210.....	223	215256.....	155	215799.....	161	257925.....	57	263544.....	113
186211.....	223	215304.....	132	215800.....	161	257926.....	57	263545.....	113
186215.....	223	215306.....	132	215831.....	159	257928.....	57	263550.....	114
186216.....	223	215307.....	132	215836.....	158	257930.....	58	264046.....	99
186604.....	147	215312.....	126	215838.....	158	257931.....	58	264047.....	99
186614.....	149	215315.....	127	215841.....	160	257985.....	58	264048.....	99
186700.....	154	215317.....	127	215851.....	159	257990.....	58	264049.....	99
186700MC.....	154	215408.....	131	215861.....	160	258301.....	52	264051.....	99
186702.....	162	215425.....	132	215866.....	160	258302.....	52	264052.....	99
186702MC.....	162	215431.....	149	215868.....	160	258303.....	53	264053.....	99
186703.....	154	215437.....	149	216011.....	149	258304.....	53	264054.....	99
186704.....	154	215438.....	148	216012.....	149	258305.....	53	264906.....	99, 220
186705.....	154	215452.....	133	216015.....	149	258306.....	53	264908.....	99
186706.....	154	215580.....	142	216130.....	148	258307.....	53	264911.....	98
186706MC.....	154	215582.....	142	238518.....	52	258308.....	54	264912.....	98
210213.....	162	215588.....	142	238519.....	52	258309.....	54	283245.....	127
211205.....	222	215589.....	142	238520.....	52	258310.....	54	303036.....	185
211207.....	222	215605.....	222	250105.....	90	258311.....	54	304042.....	185
215000.....	153	215609.....	156	250108.....	90	258312.....	54	305016.....	185

NUMERICAL INDEX

Item #	Page #	Item #	Page #	Item #	Page #	Item #	Page #	Item #	Page #
305020.....	185	330137.....	28	331591.....	27	332621.....	26	336034.....	63
310101.....	75	330138.....	28	331592.....	27	332622.....	26	336037.....	63
310103.....	75	330621.....	28	331593.....	27	332651.....	39	336039.....	63
310104.....	75	330622.....	28	331594.....	27	332657.....	39	336040.....	62
310156.....	75	330623.....	28	331595.....	27	332658.....	39	336043.....	63
310201.....	74	330624.....	28	331596.....	27	332659.....	39	336044.....	60
310202.....	74	330625.....	28	331602.....	40	332671.....	39	336045.....	61
310203.....	74	330626.....	28	331611.....	35	332672.....	39	336046.....	51, 62
310211.....	74	330641.....	28	331612.....	35	332676.....	39	336049.....	61
310212.....	74	330642.....	28	331613.....	35	332680.....	39	336056.....	62
310213.....	74	330643.....	28	331664.....	34	332681.....	39	336057.....	62
310404.....	75	330644.....	28	331666.....	34	332691.....	39	336063.....	61
310407.....	75	330645.....	28	331682.....	36	332692.....	39	336074.....	60
310408.....	75	330646.....	28	331683.....	36	332693.....	39	336075.....	60
310409.....	75	330647.....	28	331684.....	36	332694.....	39	336087.....	63
310612.....	75	331052.....	30	331685.....	36	332695.....	39	336090.....	63
310615.....	74	331054.....	30	331731.....	36	334024.....	28	336094.....	60
310712.....	75	331056.....	30	331733.....	36	334025.....	28	336095.....	60
310713.....	75	331071.....	15	331734.....	36	334026.....	28	336101.....	64
310730.....	51	331072.....	15	331735.....	36	334027.....	28	336103.....	64
310731.....	51	331073.....	15	331737.....	36	334101.....	37	336104.....	64
310732.....	51	331074.....	15	331738.....	36	334103.....	37	336105.....	62
310739.....	51	331075.....	15	331739.....	36	334110.....	37	336107.....	60
310812.....	73	331076.....	15	331803.....	41	334112.....	37	336116.....	60
311121.....	16	331077.....	15	331804.....	41	334124.....	37	336135.....	64
311141.....	16	331078.....	15	331805.....	41	334128.....	37	336151.....	62
312126.....	79	331082.....	15	331808.....	41	334177.....	37	336160.....	60
312212.....	79	331094.....	15	331811.....	36	334180.....	37	336170.....	60
312501.....	79	331095.....	15	331812.....	36	334185.....	37	336190.....	64
312502.....	79	331096.....	15	331813.....	36	334190.....	37	337000.....	67
312503.....	79	331097.....	15	331815.....	36	334191.....	37	337001.....	67
312504.....	79	331098.....	15	331817.....	36	334192.....	37	337002.....	67
312505.....	79	331099.....	15	332001.....	40	336001.....	62	337004.....	67
313004.....	27	331101.....	15	332211.....	36	336002.....	62	337006.....	67
313503.....	27	331125.....	26	332213.....	36	336003.....	62	337029.....	67
320200.....	71	331151.....	35	332214.....	36	336004.....	63	337030.....	67
320201.....	71	331183.....	26	332215.....	36	336005.....	63	337100.....	67
320211.....	71	331184.....	26	332216.....	36	336006.....	63	337102.....	67
320231.....	71	331185.....	26	332217.....	36	336007.....	61	339010.....	117
320412.....	73	331186.....	26	332221.....	36	336009.....	64	339011.....	117
321000.....	70	331204.....	35	332222.....	36	336010.....	64	339013.....	117
321004.....	69	331205.....	35	332223.....	36	336012.....	63	339016.....	117
321005.....	69	331206.....	35	332225.....	36	336013.....	63	339017.....	117
321008.....	70	331208.....	35	332227.....	36	336014.....	64	339101.....	31
321012.....	69	331209.....	35	332228.....	36	336015.....	64	339103.....	65
321014.....	69	331211.....	35	332233.....	35	336017.....	51, 62	339106.....	65
321023.....	73	331213.....	35	332235.....	35	336018.....	61	339110.....	65
321026.....	73	331270.....	42	332252.....	36	336019.....	61	339114.....	65
321200.....	72	331274.....	42	332254.....	36	336020.....	61	339201.....	31
321201.....	72	331283.....	42	332256.....	36	336022.....	64	339202.....	31
330131.....	28	331284.....	42	332282.....	34	336023.....	61	339205.....	31
330132.....	28	331286.....	42	332283.....	34	336024.....	61	339210.....	65
330133.....	28	331294.....	42	332291.....	28	336027.....	62	340001.....	96
330134.....	28	331311.....	34	332292.....	28	336030.....	64	340002.....	96
330135.....	28	331312.....	34	332602.....	40	336032.....	64	340215.....	34
330136.....	28	331313.....	34	332604.....	40	336033.....	61	340216.....	34

NUMERICAL INDEX

Item #	Page #	Item #	Page #	Item #	Page #	Item #	Page #	Item #	Page #
340217.....	34	345073.....	29	346081.....	29	370112.....	44	371422.....	43
340305.....	34	345074.....	29	346083.....	29	370113.....	44	371505.....	49
340401.....	41	345075.....	29	346086.....	29	370114.....	44	371609.....	49
340402.....	41	345076.....	29	346701.....	48	370115.....	44	371610.....	49
340403.....	41	345078.....	38	346702.....	48	370141.....	44	371611.....	49
340404.....	41	345079.....	38	346703.....	48	370142.....	44	371612.....	49
340405.....	41	345081.....	29	346704.....	48	370143.....	44	371613.....	49
340406.....	41	345083.....	29	346705.....	48	370145.....	44	371614.....	49
340407.....	41	345086.....	29	346706.....	48	371003.....	46	371615.....	49
340411.....	26	345106.....	38	346707.....	48	371013.....	43	371616.....	49
340413.....	26	345108.....	38	346708.....	48	371015.....	46	371617.....	49
340415.....	26	345109.....	38	346709.....	48	371016.....	46	371618.....	49
340416.....	26	345110.....	38	346711.....	48	371017.....	46	371619.....	49
340417.....	26	345111.....	38	346712.....	48	371020.....	46	371620.....	49
340463.....	40	345112.....	38	346713.....	48	371105.....	46	371701.....	49
340464.....	40	345113.....	38	346714.....	48	371108.....	46	371702.....	49
340466.....	40	345118.....	38	346715.....	48	371110.....	46	371704.....	49
340467.....	40	345120.....	38	346716.....	48	371121.....	21	371705.....	49
340622.....	30	345143.....	29	346717.....	48	371123.....	21	371706.....	49
340623.....	30	345151.....	38	347060.....	24	371142.....	20	371707.....	49
340624.....	30	345201.....	38	347415.....	24	371152.....	21	371708.....	49
340625.....	30	345202.....	37	347416.....	24	371153.....	21	371801.....	47
340626.....	30	345233.....	25	347417.....	24	371161.....	21	371802.....	47
340635.....	30	345234.....	25	351001.....	41	371162.....	21	371803.....	47
340637.....	30	345235.....	25	351009.....	185, 207	371201.....	47	371804.....	47
340638.....	30	345415.....	24	351209.....	185, 207	371202.....	47	371805.....	47
340853.....	15	345416.....	24	360012.....	182	371203.....	47	371806.....	47
340854.....	15	345417.....	24	360014.....	182	371204.....	47	371807.....	47
340855.....	15	345446.....	29	360016.....	182	371205.....	47	371808.....	47
340856.....	15	345448.....	29	360018.....	182	371206.....	47	371809.....	47
340961.....	15	345591.....	25, 27	360020.....	182	371207.....	47	371810.....	47
341421.....	40	345592.....	25, 27	360024.....	182	371208.....	47	372016.....	184
341422.....	40	345593.....	25, 27	361212.....	40	371209.....	47	372020.....	184
341423.....	40	345594.....	25, 27	362001.....	33	371210.....	47	372024.....	184
341427.....	40	345595.....	25, 27	362003.....	32	371211.....	47	372028.....	184
341601.....	15	345604.....	25	362004.....	32	371221.....	21	373016.....	184
341602.....	15	345621.....	25	362011.....	32	371223.....	21	373020.....	184
341603.....	15	345622.....	25	365012.....	182	371242.....	20	373024.....	184
341604.....	15	345638.....	25	365014.....	182	371243.....	20	373028.....	184
341606.....	15	345656.....	38	365016.....	182	371253.....	21	374024.....	183
341607.....	15	345657.....	38	365018.....	182	371324.....	21	374028.....	183
341629.....	30	345658.....	38	365020.....	182	371328.....	21	375312.....	50
341641.....	15	345659.....	38	365024.....	182	371330.....	21	375313.....	50
341642.....	15	345676.....	39	365028.....	182	371334.....	21	375314.....	50
341643.....	15	345678.....	39	367020.....	183	371338.....	21	375334.....	50
341711.....	16	345680.....	39	367024.....	183	371404.....	47	375336.....	50
341712.....	16	345681.....	39	367028.....	183	371405.....	47	375347.....	50
341713.....	16	345833.....	14	369024.....	184	371406.....	47	375351.....	50
341716.....	16	345834.....	14	369028.....	184	371407.....	47	375361.....	50
341717.....	16	345835.....	14	370100.....	44	371408.....	47	375363.....	50
342476.....	27	345836.....	14	370102.....	44	371409.....	47	376001.....	50
342477.....	27	345842.....	14	370105.....	44	371410.....	47	376005.....	50
342478.....	27	345933.....	14	370107.....	44	371411.....	47	376010.....	50
342651.....	41	345934.....	14	370108.....	44	371412.....	47	376012.....	50
345060.....	24	345935.....	14	370109.....	44	371420.....	49	376014.....	50
345071.....	29	345936.....	14	370110.....	44	371421.....	43	376015.....	50

NUMERICAL INDEX

Item #	Page #	Item #	Page #	Item #	Page #	Item #	Page #	Item #	Page #
376021.....	50	380257.....	106	448105.....	168	652014.....	143	690036.....	187
376023.....	50	380258.....	106	448907.....	149	652015.....	143	690040.....	187
376039.....	50	380265.....	107	455001.....	75	652016.....	143	690045.....	187
376040.....	50	380712.....	107	455003.....	75	652017.....	143	690050.....	187
376041.....	50	382012.....	108	466620.....	226	652020.....	135	691012.....	188
376061.....	50	382031.....	112	466621.....	226	652021.....	135	691014.....	188
376065.....	50	382051.....	106	466769.....	205	652022.....	135	691016.....	188
376078.....	50	383006.....	110	467012.....	226	661201.....	210	691018.....	188
376104.....	50	383007.....	109	510501.....	17	661241.....	132	691020.....	188
376106.....	50	383008.....	110	510505.....	17	661404.....	145, 212	691024.....	188
376108.....	50	383202.....	109	510508.....	17	664050.....	191	691028.....	188
376110.....	50	383205.....	106	510531.....	17	665220.....	181	692014.....	189
376112.....	50	383303.....	106	510532.....	17	665224.....	181	692016.....	189
376114.....	50	383407.....	111	510534.....	17	665228.....	181	692018.....	189
380102.....	111	383408.....	108	510535.....	17	665232.....	181	692020.....	189
380104.....	111	383410.....	105	510536.....	17	666228.....	181	692024.....	189
380105.....	111	383502.....	106	510537.....	17	668524.....	191	692028.....	189
380107.....	111	383600.....	106	511005.....	19	668528.....	191	692032.....	189
380108.....	107	383601.....	106	511006.....	19	668532.....	191	692036.....	189
380111.....	108	383607.....	106	511508.....	199	669420.....	190	692040.....	189
380112.....	111	385040.....	104	511510.....	199	669424.....	190	692045.....	189
380122.....	107	385050.....	104	511512.....	199	669428.....	190	692050.....	189
380123.....	107	400497.....	132	529560.....	141	669432.....	190	693024.....	186
380125.....	106	410105.....	99, 220	532330.....	211	670308.....	146	693028.....	186
380134.....	110	410120.....	98	532335.....	211	670316.....	146	693032.....	186
380141.....	111	421501.....	96	532340.....	211	670330.....	146	693036.....	186
380147.....	106	421503.....	96	532350.....	211	670389.....	146	693040.....	186
380148.....	112	421700.....	94	532522.....	208	675020.....	188	693045.....	186
380152.....	111	421702.....	94	532523.....	208	675024.....	188	693050.....	186
380153.....	112	421704.....	94	532524.....	208	675028.....	188	694024.....	187
380154.....	112	421705.....	94	532526.....	208	681590.....	209	694028.....	187
380158.....	112	421706.....	94	532529.....	208	681592.....	209	694032.....	187
380161.....	112	421709.....	94	532530.....	208	681598.....	209	694036.....	187
380163.....	112	421716.....	44	552102.....	206	681901.....	23	694040.....	187
380164.....	112	421717.....	92	552104.....	206	681902.....	23	694045.....	187
380165.....	112	421735.....	94	552106.....	206	681903.....	23	694050.....	187
380167.....	107	421736.....	94	552167.....	207	681911.....	23	694324.....	188
380169.....	107	421743.....	119	552730.....	205	681912.....	23	694328.....	188
380178.....	105	421805.....	83	573421.....	213	681913.....	23	694332.....	188
380183.....	105	421806.....	83	573476.....	213	681921.....	23	694336.....	188
380184.....	105	421832.....	116	610560.....	209	681922.....	23	694340.....	188
380185.....	105	423060.....	119	610561.....	209	681923.....	23	696020.....	188
380186.....	108	431220.....	116	612205.....	133	681934.....	23	696024.....	188
380187.....	109	434620.....	148	613281.....	206	685020.....	189	696028.....	188
380188.....	110	438000.....	148	613302.....	211	685024.....	189	697028.....	187
380190.....	109	438002.....	148	639001.....	197	685028.....	189	697032.....	187
380205.....	108	438004.....	148	650190.....	124, 203	685032.....	189	697036.....	187
380209.....	107	438006.....	148	650192.....	124, 203	686520.....	189	697040.....	187
380211.....	108	438008.....	148	650194.....	124, 203	686524.....	189	697045.....	187
380221.....	112	440001.....	147	650196.....	124, 203	686528.....	189	697050.....	187
380222.....	111	440020.....	147	650198.....	124, 203	686730.....	189	698024.....	187
380240.....	111	444001.....	147	650200.....	124, 203	687830.....	189	698028.....	187
380242.....	110	444002.....	149	650202.....	124, 203	687835.....	181	702212.....	196
380249.....	112	446020.....	147	650204.....	124, 203	690024.....	187	702214.....	196
380254.....	108	448006.....	149	652012.....	135	690028.....	187	702216.....	196
380255.....	108	448007.....	149	652013.....	135	690032.....	187	702218.....	196

NUMERICAL INDEX

Item #	Page #	Item #	Page #	Item #	Page #
702616.....	144	845608.....	198	M5010	164
702618.....	144	845612.....	198	M5015	164
702620.....	144	845618.....	198	M5020	164
702622.....	144	845622.....	198	M5030	164
702624.....	144	845760.....	198	M5040	164
702626.....	144	845762.....	198	M530	164
702628.....	144	845763.....	198	N3002X	163
702630.....	144	846007.....	198	N3004X	163
702632.....	144	880372.....	221	N3721	80
702636.....	144	880374.....	221	N4112	208
702640.....	144	880376.....	221	N4174	134, 210
703019.....	144	880378.....	221	N4194	126
703020.....	144	880380.....	221	N4196.....	127
703025.....	144	880815.....	221	N5700.....	222
703030.....	144	906020.....	190	P1000	164
703035.....	144	906024.....	190	P10010.....	164
703040.....	144	906028.....	190	P10015.....	164
710083.....	17	906032.....	190	P10020.....	164
710214.....	84	906036.....	190	P10030.....	164
713504.....	188	906040.....	190	P10040.....	164
713540.....	196	907012.....	191	PAP4	135
713550.....	196	907525.....	190	S3	164
713560.....	196	907528.....	190	S3015	164
713730.....	211	908036.....	191	S3025	164
713735.....	211	908040.....	191	S3040	164
713740.....	211	908538.....	191	S3-HANDLE	164
713745.....	211	909528.....	190	X3	163
713750.....	211	915901.....	183	X3015	163
713824.....	141	960102.....	47	X3025	163
713828.....	141	960103.....	47	X3040	163
713832.....	141	960104.....	47	X3-HANDLE	163
714000.....	199	970058.....	204	X5010	163
714001.....	199	982045.....	143	X5015	163
714002.....	199	990593.....	154	X5020	163
714003.....	199	990596.....	154	X5030	163
714011.....	199	991077.....	221	X5040	163
714012.....	199	60-02954	16	X530	163
714013.....	199	60-02955	16		
714021.....	197	60-04206	16		
714022.....	197	60-04207	16		
719110.....	197	60-06204	16		
720311.....	185	60-06208	16		
720312.....	185	BC-10644	154		
720358.....	181	BC-11660	154		
720360.....	186	BC-19638	154		
747010.....	199	IMP-CLAMP.....	165		
760321.....	226	IMP-GEARS	165		
760331.....	226	IMP-HANDLE	165		
773001.....	226	IMP-KNOB	165		
773002.....	226	IMP-LGHANDLE	165		
773011.....	226	LER-4030CLR	162		
773012.....	226	LER-4043	162		
774002.....	119	LER-4044	162		
779108.....	17	LER-4045	162		
779110.....	17	LER-4048	162		
845025.....	17	LER-4058	162		

Photo credits:
 © Jason Little
 © John Carey
 © Delphine Amar-Constantini
 © Fotolia

All rights reserved.

FEATURED CHEF SPOTLIGHT

@MATFERBOURGEATUSA.COM

16150 Lindbergh Street
Van Nuys, CA 91406
TOLL FREE: (800) 766-0333
contact@matferinc.com